



INTEGRA SERIES

Integra 16+

Integra 32+

v.1.2



INDEX

1.1 Introduction to Technology.....	3
1.2 Audio Input Section.....	3
1.3 Audio Output Section.....	4
1.4 Float Point DSP	4
1.5 Audio Flow	6
1.6 Typical System Application	7
2.1 Safety Instructions.....	9
2.2 Audio Wiring Reference.....	10
2.3 Specifications	11
2.4 Mechanical Data.....	12
2.5 Front Panel.....	12
2.6 Rear Panel.....	13
3.1 Software Installation	14
3.2 Using the Software.....	15
3.3 Custom edit processing module.....	15
3.4 Audio Module Parameters.....	16
3.5 Setting Menu.....	32
4.1 External Control Programmer	40
4.2 Control Protocol.....	40
4.3 Serial Port-to-UDP (RS232 To UDP).....	43
Appendix A: Module ID Distribution.....	45
Appendix C: ASCII control command.....	48

1. Technology Overview

1.1 Introduction to Technology

DSP Series are equipped with several core technical features to facilitate the work of audio engineers. DSP-based remote audio hardware is routed, processed and controlled via computer. This Manual mainly introduces the techniques used to achieve the goal.

DSP Controller is a Windows-based application, which is used to conduct configuration and control on DSP hardware. DSP Controller has 16 built-in presets, and the modules and sequences for each preset can be flexibly designed in accordance with the designer's requirements. After the design is finished, it can be saved for future use. The sequences and parameters of DSP Controller's built-in processing modules accord to most of the application scenarios without any change.

DSP Controller is a full-featured application including the parameter adjustment and peripheral accessory settings of all modules, such as RS232, RS485, click-and-drag panel configuration and Dante network audio control etc. The most interesting part is the user interface, which allows the engineer to customize user interface so that the integrator can edit it or the onsite technicians or end users who have no idea of relevant techniques can operate it. Superior safety functions make it possible for the end users to access to the controls allowed by the engineer or designer.

1.2 Audio Input Section

DSP supports up to 16 fixed analog audio inputs, which can be connected via removable balanced Euro-Block connectors. The analog input section supports microphone or line-level signals whose nominal levels are from 0dBu to 48dBu in 3 dBu steps +48VDC phantom power can be adopted for each input.

Preamp gain and phantom power can be conveniently controlled via software.



A/D Technical Indicators:

Sampling rate: 48kHz

THD+N: 105dB

Dynamic range: 120dB

Audio format: 24Bit MSB TDM

1.3 Audio Output Section

Analog output section refers to D/A converter (DAC). DSP adopts advanced 24-bit 256X sampling converter. Just like A/D converter, it also uses multi-bit architecture for broader dynamic range; in the meantime, it is also equipped with excellent distortion just like regular digital unit analog converter. Unit gain (0dB) is set via volume control, and the analog output section is corrected as +4dBu with 20dB headroom. That is to say, 0dBFS digital signal is equivalent to +24dBu output signal. If other signal levels are required, you may change the volume to achieve it.

D/A Technical Indicators:

Sampling rate: 48kHz

THD+N: -100dB

Dynamic range (A-weighted): 118dB

Audio format: 24Bit MSB TDM

1.4 Float Point DSP

DSP device adopts analog device SHARC DSP, enabling 32-bit and 40-bit floating-point processing, which can be compared to 40-bit floating-point processing of other devices. Floating-point processing provides prominent advantages for the users in terms of sound quality and usability.

Fixed-Point Processing Limitations

Fixed-point processing has its own disadvantages. If there is a significant change in gain, data loss or more severe situation may occur, including clipping distortion. For example, for the processing of 24-bit fixed point-based audio signal, in some cases, if you attenuate the signal to 42dB, the new signal only includes 17-bit information. Due to gain attenuation, 7-bit information will get lost forever. Worse is the clipping distortion. For a signal nearly close to 0dBFS, the signal will be clipped at 0dBFS, and the audio distortion will occur. Even if the signal level is adjusted to below 0dBFS through post-regulation, the clipping has occurred, and the distortion still exists. Fixed point processing can help to create some headroom above 0dBFS. By doing so, some bits have to be abandoned. For example, if a 12dB (2 bits) headroom is created, a 24-bit system actually only has 22 bits.

Floating-Point Processing

In the contrary, by taking advantage of floating-point processing, no matter what the signal level is, all available bits are uniformly distributed to the signals. Basically, the floating points use some bits as indexes to set up general signal level and distribute the remaining bits to signals with independently stored level. As a result, no matter what kind of level (from -200dB and 200dB below to 0dBFS above, the stored signal's accuracy is optimized without clipping distortion. SHARC provides 32-bit and 40-bit accurate processing; through 32-bit processing, 25 bits are distributed to storage signals no matter what its signal level is. This means that, based on at least 1-bit low level signal, its accuracy is always significantly superior to 24-bit fixed point processing. Through expanded 40-bit accurate processing, 33-bit storage signal can be achieved.

Practical Significance

What's the practical significance of floating point processing for the users? The gain stages between multiple modules can be ignored. If the signal level of a module is reduced by 50dB and is then restored to its original value through another processing, data loss will not occur. In the fixed-point system, the users must check other signal levels before sending it to A/D converter because all digital-to-analog converters adopt fixed points. In DSP system, if you notice that your signal has been clipped before it is outputted and transmitted to the digital-to-analog converter, you may close it off immediately at the output section to correct the situation. By using the fixed point system, you have to search each processing module to find the clipping source.

1.5 Audio Flow

Input flow

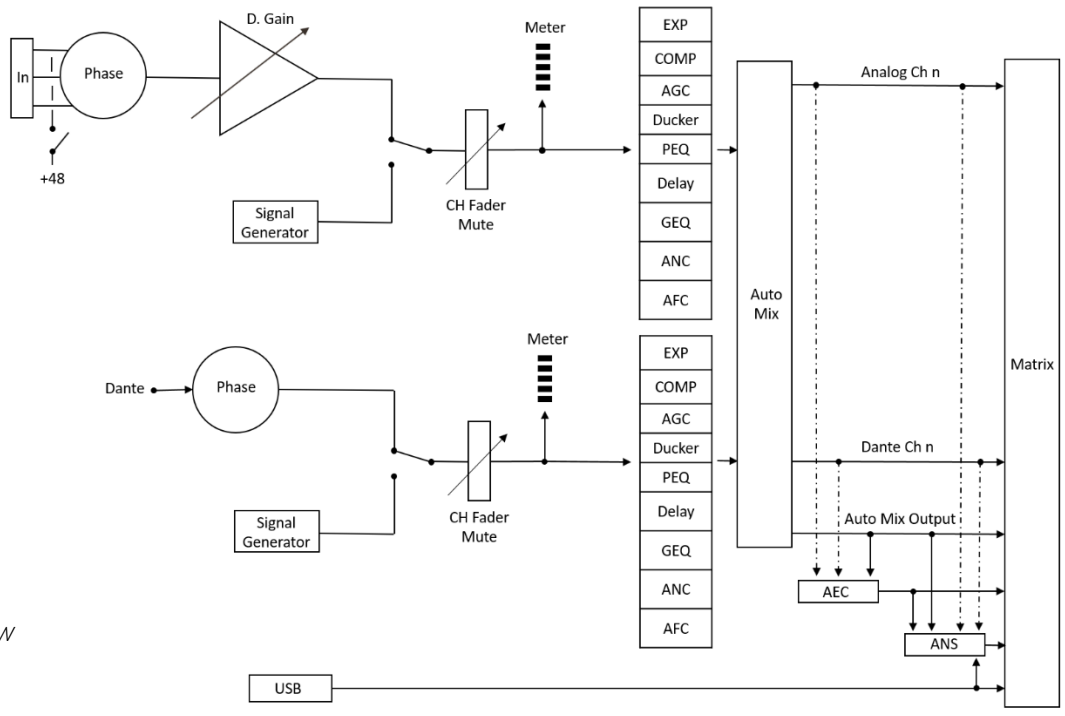

Output flow

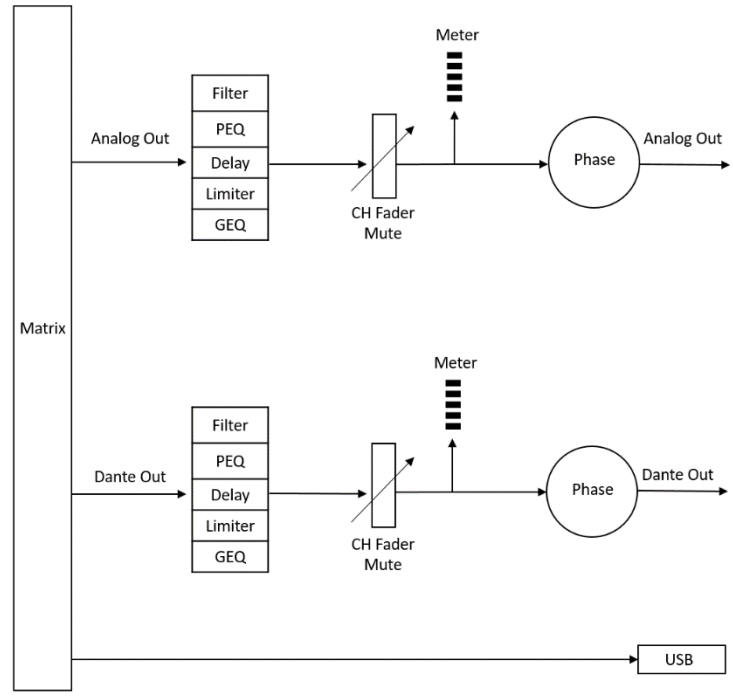

1.6 Typical System Application

Conference Amplifying System: The processor can be connected to capacitor microphone, local output amplifier and speaker so as to decorate and process with the signals via the speaker on output channel. The output signal can also transmitted to the recording device with Dante interface via such interface, such as computers with Dante virtual soundcard. By adopting a simple control panel, volume adjustment, scenario call and other functions can be achieved via UDP control processor.

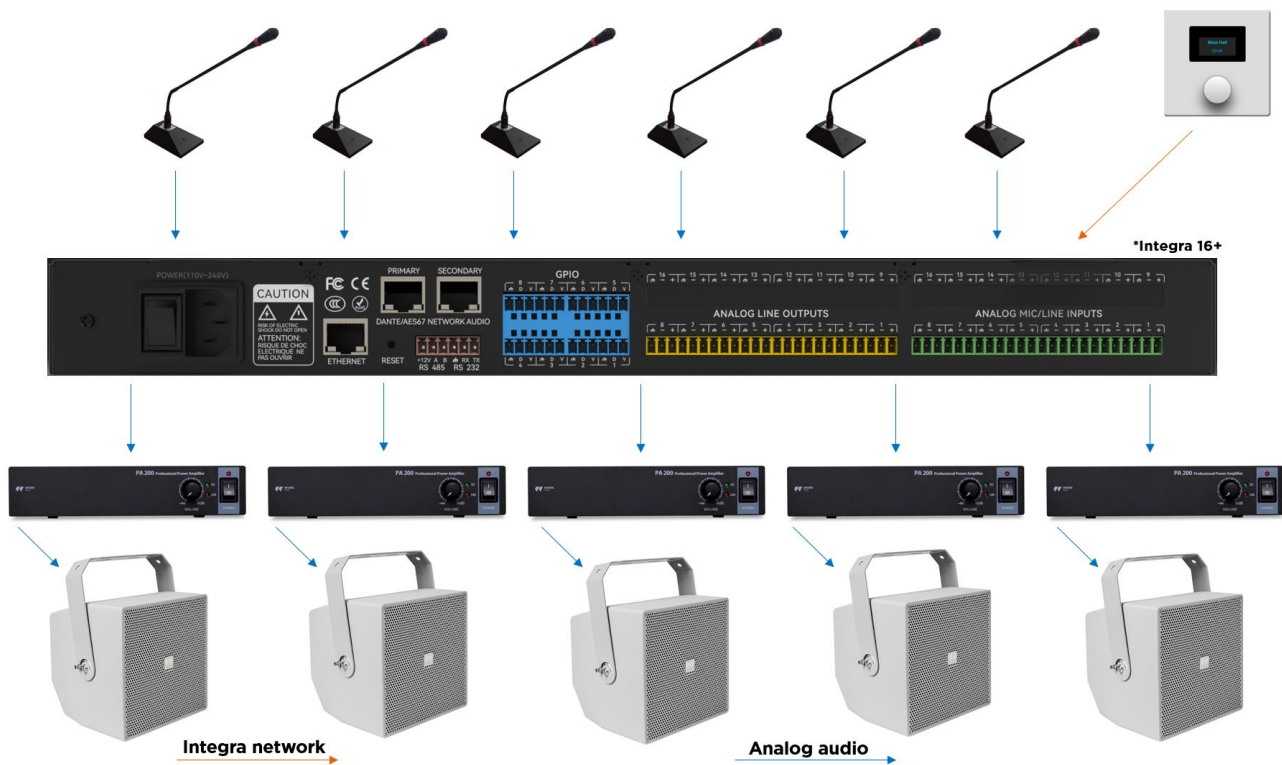

Dante Application: Dante network breaks through space limitations and has a wide range of application scenarios. It can connect all devices that support Dante protocol to the same local area network. By cascading 2 DSPs, it supports the access of up to 16 analog microphones and 16 Dante microphones. Each processor will conduct first-level auto mixing on its own microphones, and the second-level auto mixing is then made on the mixed signal via the auto mixer of main processor so that more microphones can be connected to build a larger auto mixing matrix. The two-level auto mixing working mode can satisfy general application scenarios.

These are two of the most common topologies for a Dante network, considering the type of devices.

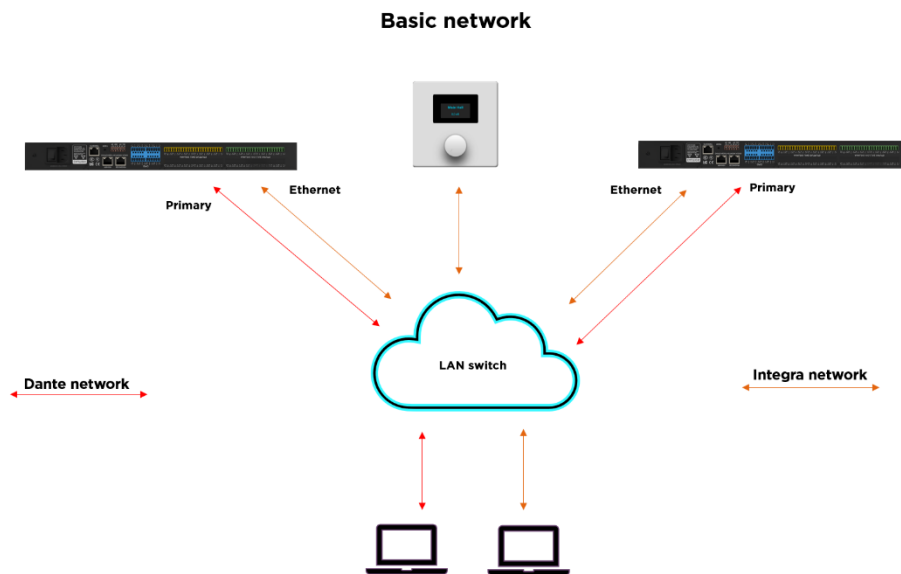

Dante Daisy chain configuration

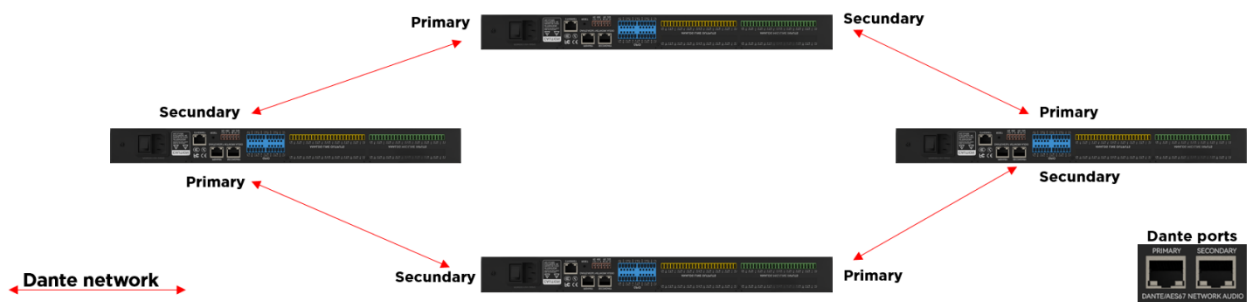

It is recommended to have basic knowledge of network configuration, addressing and the use of tools such as VLANs.

2. Hardware

2.1 Safety Instructions

Safety Instructions

Important safety instructions:

1. Read these instructions.
2. Keep these instructions well.
3. Pay attention to all warnings.
4. Follow all instructions.
5. Please keep the device away from water. The device shall not be exposed to water drips or water splashes; make sure that there is no object with liquid near the device, such as vase.
6. Please use dry cloth to clean up the device.
7. Please do not block the vent. Please get the device installed based on the manufacturer's instructions.
8. Please do not install any heat source, such as radiator, heat register, furnace, or other devices (including amplifiers) that generate heat.
9. Please adopt protective grounding connection to connect the device to the power socket. Please do not use polarized plug or grounding plug. A polarized plug has two leaves, and one is wider than another. A grounding plug has two leaves and a third ground terminal. The wide leaf or third ground terminal can provide safety for the users. If the plug provided does not accord to the power socket, please contact the electrician to replace the old socket with a new one.
10. Protect the power cord so that it will not be tramped or protruded, especially the plug, the socket and the connections of cord and device.
11. Please use the accessories designated by the manufacturer.
12. Please only use the cart, the tripod, the holder, or the desk designated by the manufacturer or sold together with the device. When using the cart, please take care with the mobile cart/device to avoid injury from rollover.
13. Please unplug the device during a thunderstorm or during the idle period.
14. Please find qualified maintenance personnel to deal with all maintenance problems. When the device gets damaged in any manner, the maintenance is required. For example, the power cord gets damaged, the liquid will spill over, or the object falls into the device; the device is exposed to the rainwater or moisture; the operations are not correct, or the device falls off.



WARNING: TO REDUCE THE RISK OF FIRE OR ELECTRIC SHOCK DO NOT EXPOSE THIS EQUIPMENT TO RAIN OR MOISTURE

AVIS: RISQUE DE CHOC ELECTRIQUE NE PAS OUVRIR

SEE OWNERS MANUAL. VOIR CAHIER D'INSTRUCTIONS.
 No user serviceable parts inside. Refer servicing to qualified service personnel.
 Il ne se trouve a l'interieur aucune piece pouvant entre reparaee l'usager.
 S'adresser a un reparaateur competent.

The lightning logo (an equilateral triangle with an arrow) is used to make the users aware of the uninsulated "dangerous voltage" within the product shell, which may cause electric shock. An equilateral triangle with an exclamation mark is adopted to make the users understand the importance of the operations and maintenance instructions given in the appendixes attached to the product.

Warning: In order to prevent electric shock, please do not use a polarized plug provided by a device with an extension cord. The socket outlet cannot be inserted except for sharp end.

2.2 Audio Wiring Reference

Balanced Connection

Any of these interfaces may occur on both sides of the connection.

Note: For one XLR interface, the female connects to the output device and the male connects to the input device.

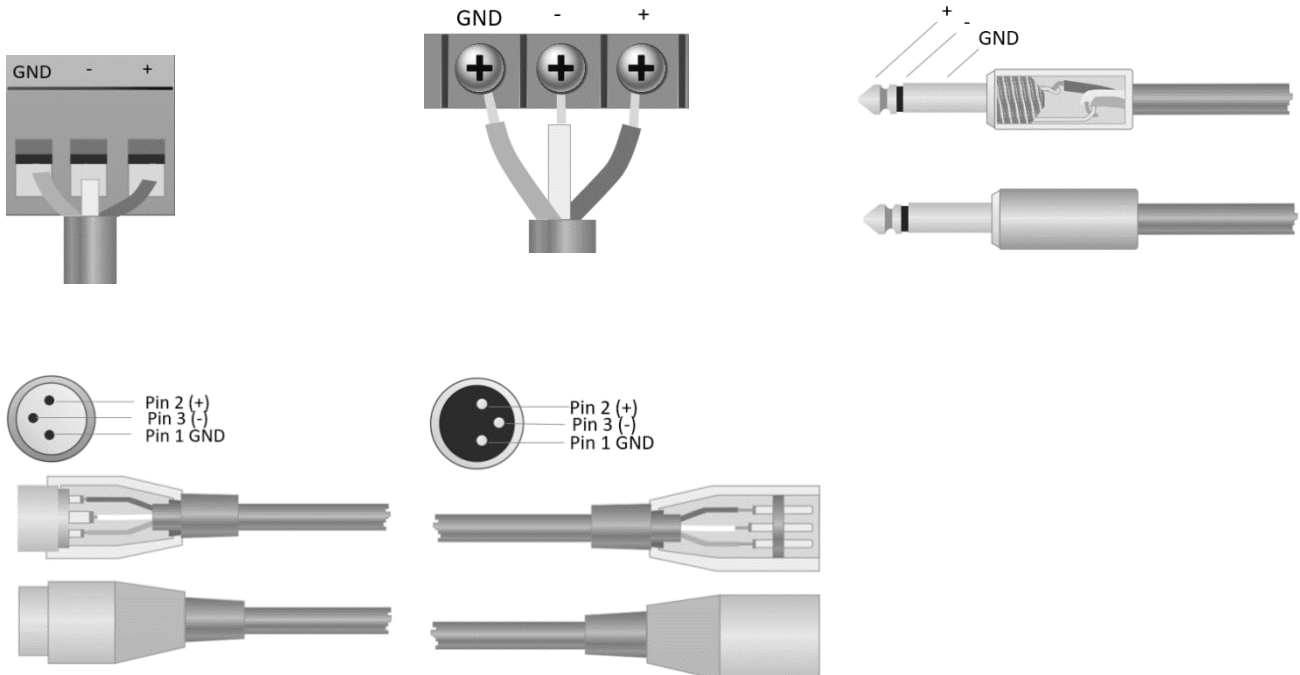

Unbalanced Connection

RCA interface and 1/4-inch TS interface are unbalanced interfaces. A multi-stand shielding conductor may be installed on both ends of unbalanced connection.

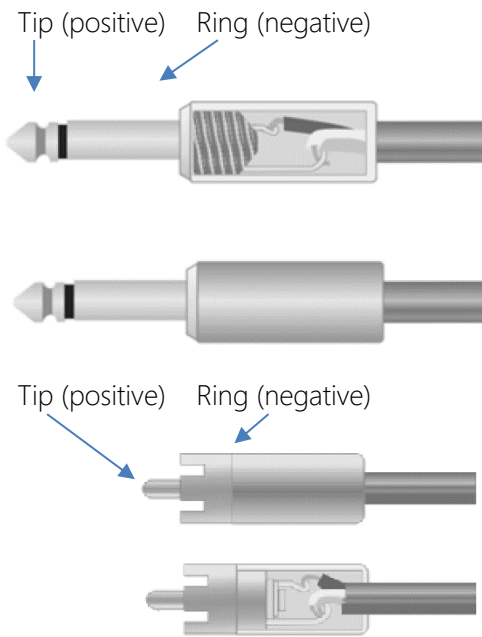

2.3 Specifications

Take 16x16 as an example (including Dante).

Processor	ADI SHARC 21489(x2)
Sampling rate/Digitalizing bit	48K/24bit
Input Gain	0dB to 48dB (3 dB steps)
Phantom Power	48V
Frequency Response (20~20KHz)	±0.2dB
Maximum Level	+18dBu
THD + Noise	0.003%@4dBu
Dynamic Range	110 dB
Background Noise (A-weighted)	-91 Db
Common Mode Rejection Ratio @60Hz	80dB
Channel Isolation @1KHz	108 dB
Input Impedance (Balanced Connection)	9.4KΩ
Input Impedance (Balanced Connection)	102Ω
System Delay	<3ms

Working Power	AC110~240V 5Hz-60Hz
Maximum Power Consumption	<40W
Dimensions (Width x Depth x Height)	482 x 260 x 45mm
Shipping Weight	3KG

2.4 Mechanical Data

Space required:

1U (width * depth * height: 18.91" x 9.5"x 1.72" / 48.02 cm x 24.13 cm x 4.37 cm). The reserved head space is not included in the depth.

An additional space at least 3 inches shall be reserved for the connection of rear panel. The reserved depth depends on the wire used and the connection mode.

Electrical Property:

Maximum universal input power: 110~240 VAC, 50/60 Hz, 40 W.

Ventilation:

The recommended highest operating ambient temperature is 30°C / 86°F.

Make sure that there is no blockage on both sides (a gap (at least 5.08cm, 2 inches) shall be reserved). Please do not cover the breather of the device with papers, table cloth, curtain and other objects.

Shipping Weight:

6.6 lbs. (3 kg)

2.5 Front Panel

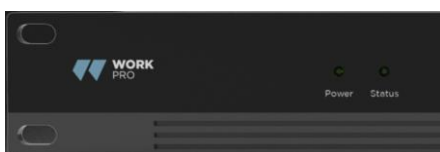

Power: LED power indicator.

Status: The operation status indicator of the device.

USB connector: USB soundcard (1x1), which can be used to achieve recording function.

2.6 Rear Panel

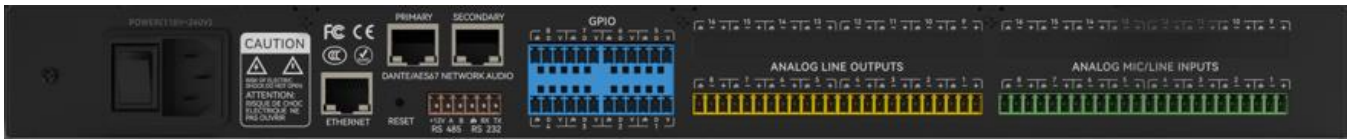

Integra 16+

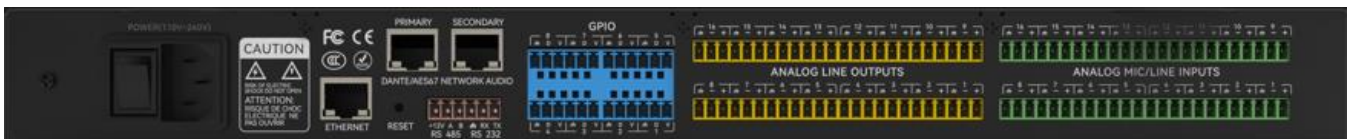

Integra 32+

Power Source:

Power switch

Fuse

Power connector: (Support 110–240V AC 50/60Hz, and support a maximum power of 40W)

Ethernet Connector

10/100 Base-T Ethernet connector is used for IP-based PC software and host control and third-party accessory controller.

Dante Connector

Dante (Level 1)

1000 Base-T Ethernet connector, provide up to 32 (16x16) channel Dante network audio.

Dante (Level 2)

1000 Base-T Ethernet connector, used for redundancy Dante network audio under the redundancy mode, or the devices connected in daisy chain without all external exchanges, and the settings under the exchange mode.

RS485

Used for the serial communication port with A and B port, use the +12v aux port if were necessary. RS485 can be used for voice tracking control (or other output commands), or for bus input control. A central command can be used to conveniently integrate it into your software.

Port setting: 115200 baud (default), 8 data bits, 1 stop bit, no parity, no flow control (configurable via software).

RS232

Used for the serial communication port Tx = sending or data output or Rx = receiving or data input that connects to a third-party control device.

Port setting: 115200 baud (default), 8 data bits, 1 stop bit, no parity, no flow control (configurable via software).

GPIO

General purpose ports. After being activated, the logic output will be low (0V), and the internal voltage will be higher (5V) when being not activated. You may directly light up external LED indicator. Inputs can manage actions on the device also set variable values with the analog to digital function.

3. Software

3.1 Software Installation

A Windows PC with a processor of 1 GHz or higher and:

Windows 7 or higher version.

1 GB free storage space.

1024 x 768 resolution.

24 bit or higher color.

2GB or higher memory.

Network (Ethernet) port.

CAT5 cable or current Ethernet network

1. Download software from the website below and install files.
2. Double click the downloaded file and install by following the instructions on the screen.

After the software is installed, read other parts of the help file or execute the software.

After the software is installed, use one of the following methods to enable the software:

1. Desktop icons:
2. Start menu:

When starting the software for the first time, it may take some time (1-15s) to start it. Please wait for a while.

3.2 Using the Software

After enabling the software, the main menu is shown as below:



Click the button **Device List** in the right corner of the main menu and find all processors on the network automatically. The user may connect to the designated processor based on their own needs; after the connection, the indicator will flash, and one processor supports simultaneous connection and control of up to four users.

3.3 Custom edit processing module

Click on the edit button, input or output channel processor module right-click selection, edit dialog box, can replace the current processing module, can delete, copy and other operations.

Note: when some CPU display more than 100 will turn red, this time the resource cannot be uploaded to the host, need to be re-edited. Each model has different modules available.



3.4 Audio Module Parameters

There are two regulation modes for module parameters: firstly, directly click the input or output channel modules, and enter the parameter interface of the module; secondly, right click the module and the configuration interface will pop out. The first regulation mode is adopted for the following module parameters.

3.4.1 Input Source



Sensitivity: Increase the level of the input signal, 16 steps of 3dB. Obviously in Dante channels the sensitivity is fixed to 0dB.

Phantom Power: Provide power for external condenser microphones, click the button if needed.

Input as signal generator:

Sine Wave: Drag the frequency to generate sine wave with designated frequency (20~20 kHz). You may regulate the output level (unit: dBfs) based on your own needs. Use a fader to adjust or click the text field to designate a value.

White Noise: Observe it on the frequency spectrograph with constant bandwidth, which has a flat frequency spectrum. At this time, frequency regulation will fail, and the level can be used. Each frequency component of white noise has equivalent energy.

Pink Noise: The frequency component powers of pink noise are mainly distributed in the middle and low frequency bands. It decreases with a speed of 3dB/Oct (a.k.a. crest factor) in the middle and low frequency bands.

Group Setting: Open the group setting interface swiftly. Clicking mouse right button over the fader module.

Minimum and Maximum Gains: Limit the maximum and minimum of the gain of a channel. After it is commissioned, if you do not wish that the system's stability is affected due to external factors, you may set up a maximum gain.

In addition, you may also find the following menu by right clicking each fader on the main menu.

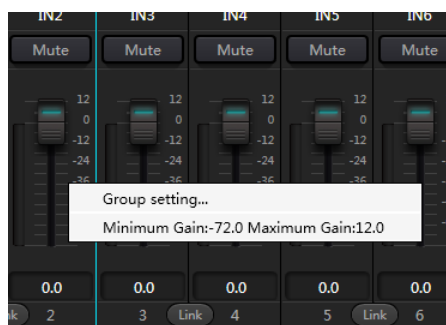

3.4.2 Expander

The expander has a totally different principle from the compressor. It can expand the dynamic range of a signal. The most fundamental difference in these two devices lies in that, the compressor works on the signal higher than the threshold, while the expander works on the signal lower than the threshold. The expander can turn small signal into smaller one. It can be seen from Fig.3.2 that, when the expansion ratio reaches 1:2, the input signal 20dB lower than the threshold will generate an output signal 40dB lower than the threshold. Thus, as shown below, the signal lower than the threshold will extend downwards and cause smaller level. When an expansion ratio 1:20 is adopted. The expander seems to be a noise gate in terms of the transmission features. In fact, a noise gate is an expander with great expansion ratio.

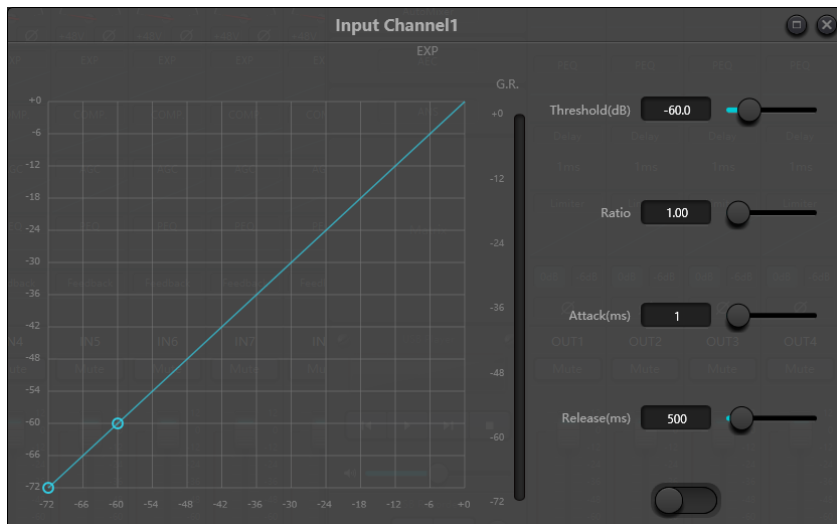

Fig.3.2 Expander

The expander has the following control parameters:

Threshold: The expander can be started only when the signal exceeds this threshold (allowing the transmission of the signal). As a matter of fact, the signal is often set as the ambient noise.

Ratio: It refers to the relation below the threshold point on the gain curve. When the ratio is set at a high level,

Attack: It refers to the time required to start the expander when the duration of the input signal exceeds the threshold. Shorter starting time allows us to start the expander more quickly.

Release: It refers to the time required for the gain to be restored to a value lower than the threshold when the input signal is lower than the threshold.

No matter the starting time or the release time, it just helps to reduce the changing speed of gain attenuation. That is to say, the value of the gain from -40dB to 0dB is slowed down due to the influence of starting time. The starting time or release time is unrelated to the threshold. If the signal changes below the threshold, the starting time and the release time will have their own respective influence on gain attenuation; when the signal level rises above the threshold, the gain attenuation produced by the expander will disappear in accordance with the speed controlled by the starting time. When the gain attenuation is reduced to 0dB, the expander will stop expansion. Later, when the signal reduces to below the threshold, the expander will start again, and the release time will begin to work.

3.4.3 Compressor & Limiter

Compressor

The compressor is used to reduce the dynamic range of the signal higher than the threshold set by the users, and to maintain the dynamic range of the signal lower than the threshold. The compressor has the following control parameters:

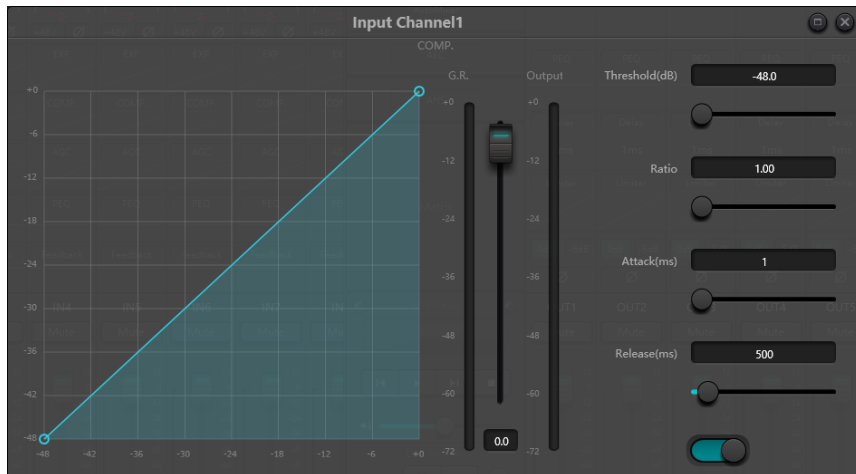

Threshold: When the signal level is higher than the threshold, the compressor/limiter begins to reduce the gain. Any signal that exceeds the threshold is regarded as overshoot signal, and its level will be reduced in normal cases. To a greater extent the signal exceeds the threshold, more level is attenuated.

Ratio: It refers to the compression ratio. The ratio decides the attenuation degree of the overshoot signal to the threshold level. The smaller the compression ratio is, more easily the signal will be higher than the threshold. Once the signal exceeds the threshold, the compression ratio decides the ratio of input signal variation to output signal variation. For example, when the compression ratio is 1:2, if the input signal is 2dB higher than the threshold, the exceeding part only changes by 1dB. A compression ratio of 1:1 suggests that the compressor does not attenuate the signal in proportion. The adjustable range of compression ratio is from 1 to 20.

Attack and Release: In order to maintain natural oscillation, it is generally hoped that part of the most original level will pass through the compression without any influence (or just minor influence). Likewise, if there is a rapid sharp attenuation and rapid recovery in the signal gain, the suction effect will occur. The starting and release time of the compressor is to avoid such circumstance. The starting time can decide the speed of gain attenuation, while the release time decides the speed of gain recovery.

Output Gain: It is also called gain compensation fader. If the compressor significantly reduces the level of the signal, it may need to enhance the output gain to maintain the volume. Such enhancement applies to all parts of the signal and is unrelated to other parameter settings of the compressor.

Gain Reduction and output Level Meter: G.R. indicates the compressor's compression amount; output refers to the output level of the signal that has passed through the compressor module. The compression amount is displayed in an inverse level meter. If the input signal and threshold are set as -6dB and -30dB, respectively, and the ratio is 2:1, then the compression amount is 12dB; G.R. level meter indicates around -12dB and output indicates around -18dB.

Limiter



The limiter only has one key task: make sure that the signal will not exceed the threshold level in any case. By adjusting the compressor's control parameters, its working modes will be very similar to those of the limiter. The core working principle of a limiter is that it really focuses on the signal below the threshold level as well as how the gain attenuation is produced before the occurrence of overshoot signal. The limit period consists of two processing stages: during the first stage, there is a minor limit, but the overshoot signal will not be processed; during the second stage, if there is overshoot signal, it will attenuate in a very fierce way.

The limiter only provides two parameters: Threshold and Release. In terms of signal processing, occasional clipping will be solved via limiter, while the signal level shall be attenuated in terms of frequent clipping.

3.4.4 Auto Gain Control

Auto Gain Control (AGC) is an exception of compressor. Its threshold is set at a very low level with middle-to-slow starting time, long release time and low ratio. The purpose is to improve the signal with uncertain level to a target level, while maintaining the dynamic range at the same time. Most of the auto gain control includes silent detection to prevent the gain attenuation loss during the silent period. This is the only function that distinguishes auto gain control from ordinary compressor/limiter.

Auto gain control may be adopted to normalize the level of devices that play background music, music on hold, so as to eliminate the changes in the level of some paging microphones.

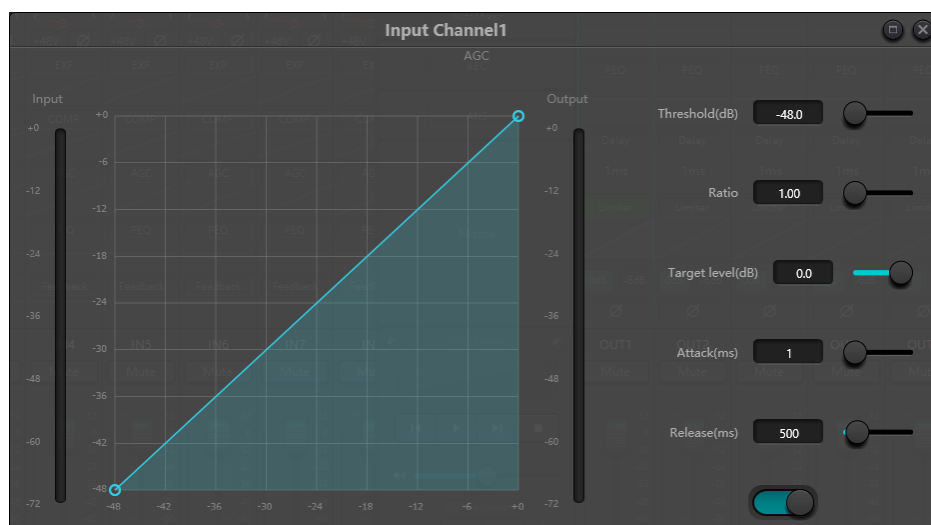

Auto gain control includes the following control parameters and switches:

Threshold: When the signal level is lower than the threshold, the input-to-output ratio is 1:1. When the signal level is higher than the threshold, the input-to-output ratio changes with the ratio control settings. The threshold is set as the background noise just higher than the level of input signal.

Ratio: It refers to the ratio of the changes in the level of the input signal higher than the threshold to the changes in the level of the output signal.

Target Level: It refers to the level of output signal required. If the signal is higher than the threshold, the controller will compress the signal in proportion.

Attack: It refers to the response time required to control the level higher than the threshold.

Release: It refers to the response time required to control the level lower than the threshold.

3.4.5 Parametric EQ

The equalizer is mainly used to correct the frequency range that is overemphasized or gets lost, no matter it is wide or narrow. In addition, the equalizer can also help us to narrow or widen the frequency range or change the amount of a component in the frequency spectrum. To get it simplified, the equalizer can be used to change the tone of the signal.

The equalizer has the following control parameters:

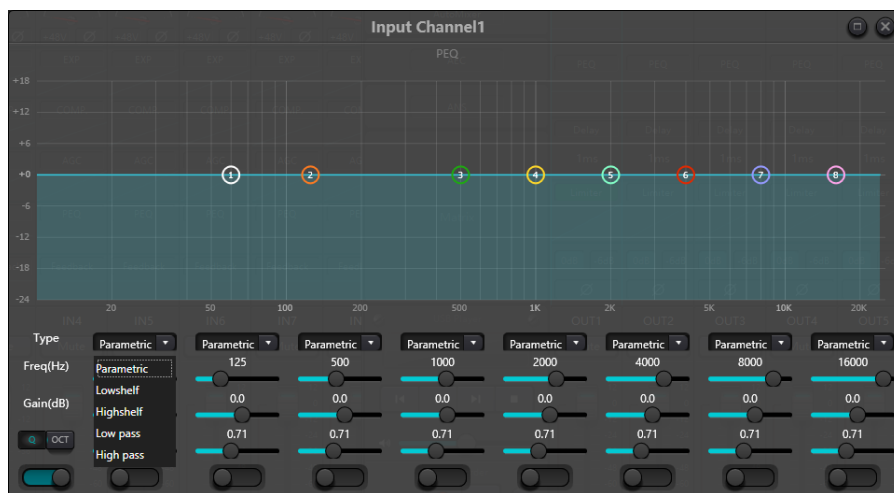

Equalizer

Type: Parametric EQ is a default. High & low shelf filters and high & low pass filters can be selected. Each kind of filter has different forms to achieve different functions.

High & Low Pass Filter: The reference frequency of pass-type filter is called cut-off frequency. Pass-type filter allows the frequencies on one side of the cut-off frequency to fully pass the filter; in the meantime, the frequencies on another side of the cut-off frequency are attenuated on a consecutive basis. Among them, high pass filter allows the frequencies above the cut-off frequency to pass and filter the frequencies below the cut-off frequency. To the contrary, low pass filter allows the frequencies below the cut-off frequency to pass and also filter the frequencies above the cut-off frequency.

High & Low Shelf Filter: It is also called shelf filter. High shelf filter means that the gain enhances or attenuates for the frequencies above the set frequency. Low shelf filter means that the gain enhances or attenuates for the frequencies below the set frequency. The set frequency is not 3dB cut-off frequency but refers to the center of the falling edge or rising edge of the filter. Q value affects the peak and has a mathematical relation with the peak.

Frequency (Hz): It refers to the center frequency of the filter.

Gain (dB): It refers to the enhanced or attenuated decibel value of the gain at the center frequency.

Q: It refers to the quality factor of a filter. The adjustable range of Q value is from 0.02 to 50;

When the filter is a parametric EQ filter, Q value refers to the width of the bell-shaped frequency response curve on both sides of the cut-off frequency.

When the filter is a high & low shelf filter or a high & low pass filter, if $Q > 0.707$, there will be peaks in the filter responses. If $Q < 0.707$, the slope will become flatter, and the roll-off will occur in advance.

Each segment of equalizer has a switch, which is used to turn on or turn off the corresponding segment. After being closed, the parameter setting will not work. The equalizer has a master switch, which is used to enable or disable a module.

PEQ have 5,8 and 12 bands options.

3.4.6 Graphic EQ

By using constant Q value technology, each frequency point is equipped with a slide potentiometer. The bandwidth of the filter remains unchanged regardless of the frequency raised or attenuated. The common professional graphic equalizer is to divide 20 Hz~20 kHz signals into 10,15,27 or 31 bands to adjust.

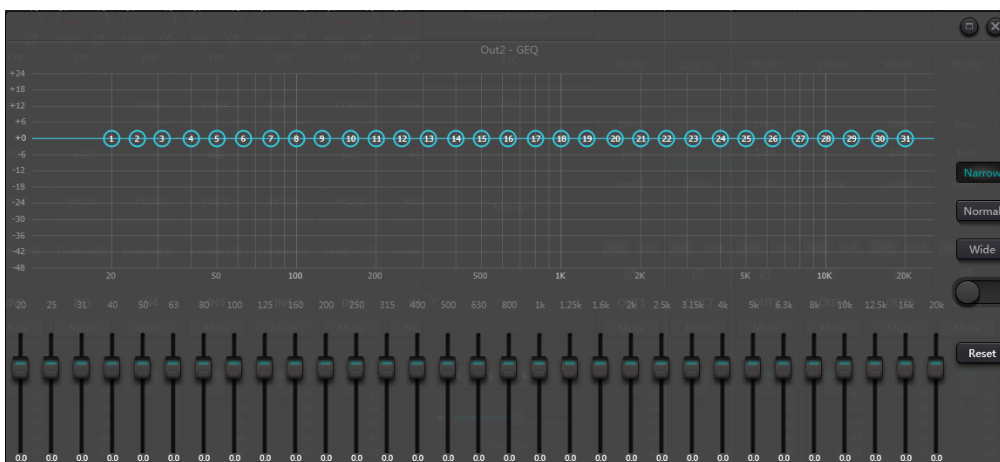

3.4.7 AFC

While using the Acoustic Feedback Canceller, we'd better combine well with good systematic designs and practical projects but not to replace good systematic designs. The traditional methods shall still be used, such as limiting the number of microphones to be opened, minimizing the distance between sound source and microphone, placing the microphone and loudspeaker to get minimum feedback, and balancing the room to get flat response. Later, we can adopt feedback inhibitor to get additional gain. The feedback inhibitor cannot be used to magically solve the system's design defects or improve the sound transmission gain in a way exceeding the system's physical limitations.

Feedback inhibition module automatically detects and inhibits the sound feedback in the sound system. The module distinguishes feedback from expected sounds based on the characteristics of signals. When feedback at a certain frequency is detected, a notching filter will be automatically added at the feedback point to attenuate it. During the first addition, the notching filter only attenuates the feedback a bit. If the feedback still exists, the notching filter will continue to attenuate the feedback in accordance with the preset parameters until the feedback disappears.

or reaches the maximum preset parameter. Multiple user parameters can be used for accurate fine tuning of the effects of the module.

The filter settings can be copied to a dedicated notching filter module (such as equalizer). Eight filters are set as auto filters in an automatic cycle. In this way, those filters for temporary use can be removed.

Each channel has a feedback inhibition. Use a mouse to drag the input module and find the feedback inhibition module or rapidly enter the feedback inhibition module by clicking the shortcut key on the right. If the feedback inhibition module needs to be enabled, click to enable the button, and automatically detect the feedback point, and use a narrow-band filter for elimination. Each feedback inhibition module has 8 narrow-band filters.

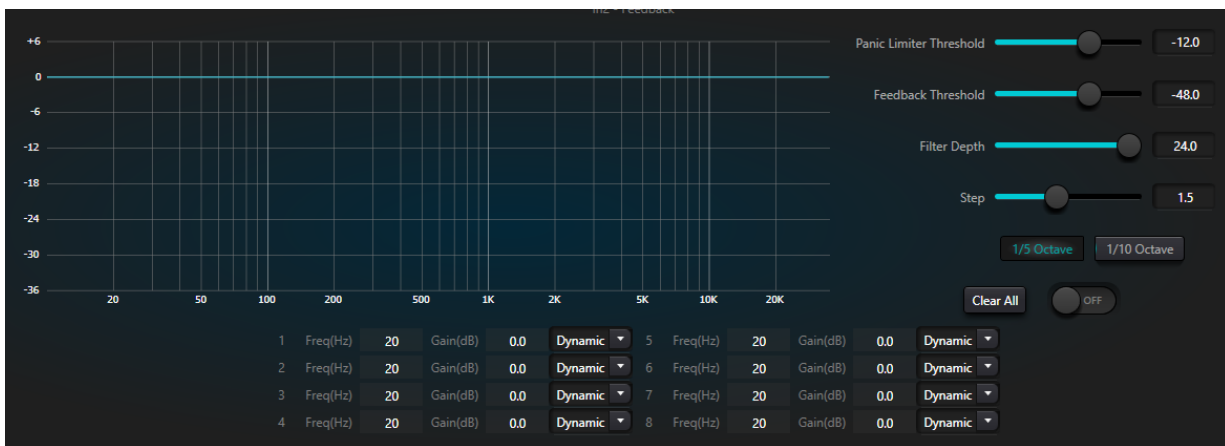

The feedback inhibition module has the following adjustable parameters:

Panic Threshold: According to this parameter, "any level higher than the threshold is absolutely feedback". When a signal level is higher than the feedback threshold, any of the following circumstances will occur.

- a) the output gain is temporarily attenuated to control the speed of feedback.
- b) the output level is restricted to prevent out of control.
- c) the filter's sensitivity is increased for faster detection and feedback.

Once the output level is lower than the threshold, the gain will be recovered, and the sensitivity is restored to normal state. This value refers to the peak value of digital range signal. If the value is set as 0, this function is disabled.

Feedback Threshold: According to this parameter, "any level lower than the threshold is absolutely not feedback". This may prevent the module detects feedback in a soft music or due to the noise of low level.

Filter Depth: It refers to the maximum attenuation of a single filter. A shallow setting may prevent too much damage caused by the filter or notching filter to the signal. It may cause worse feedback control, especially in a large narrow resonance system.

Bandwidth: 1/10 and 1/5Oct can be chosen. A constant Q value is adopted. The filter will not become wider due to the increase of depth. It is recommended to use the filter in the phonetic environment. In the case of frequent feedback, the bandwidth is set at 1/5Oct because it has wider bandwidth and greater influence.

Notching Filter's Auto Mode: Auto mode is set for the notching filter. After eight filters are used up, new feedback is detected, and the module will check "auto" filter and use it to inhibit new feedback. Each notching filter has three modes: auto, manual and fixed modes. When Manual mode is set for the filter, the gain can also be manually set. When Fixed mode is set, the filter always works and will not be occupied by new feedback points; it still works when being rebooted. If you need to save these feedback parameters, please click to save the preset button.

Clear: Click the button to instantly clear up all filters. It will clear up all feedback points detected with inhibition previously. This operation is generally done when recommissioning the feedback module.

Feedback inhibitor can be **used as a tool** during the system commissioning to identify feedback points or as a preventive measure during normal operations. If you want to get higher system transmission gain and feedback inhibition effect, it is recommended that you debug by following the steps below:

Procedure:

- a) Reduce the system gain, and use the button "Clear" to reset all filter parameters
- b) Set up parameters for the feedback inhibition module. Also, decrease the panic threshold to reduce the feedback level.
- c) Open all microphones, and slowly increase system gain until the feedback occurs. Stop increasing system gain when the feedback occurs.
- d) Wait for the feedback inhibition module to take effect; after the feedback disappears, continue to increase gain.
- e) Repeat the operation until the system reaches the required gain or until all filters are fully distributed
- f) Change the panic threshold to a maximum level just higher than the expected non-feedback signal.

At this time, if needed, save the dynamic status to deal with possible feedback during the performance period. Additionally, you may copy the filter to the notching filter module (such as equalizer). In this way, you may add more filter capacity.

If a speaker is included among the devices used, it is recommended to use a compressor/limiter module for additional protection. You may set an appropriate limiter to make sure that the speaker will not get damaged even if all notching filters are used up or the feedback inhibitor cannot effectively control the feedback, such as in the case of excessive system gain.

3.4.8 Gate

Gate: the main purpose of a noise gate is to attenuate signals below the threshold, and this attenuated signal is usually noise or background.

Threshold: Refers to the level of the signal that will trigger the process, in this case sound appearance.

Depth: attenuation, which determines how much the signal below the threshold is attenuated.

Attack: Time taken for the process to reach its full effect.

Hold: It is the time after activation that maintains the process or the desired relation before time release begins.

Release: Is the time it takes for the process or reaction to disappear completely.

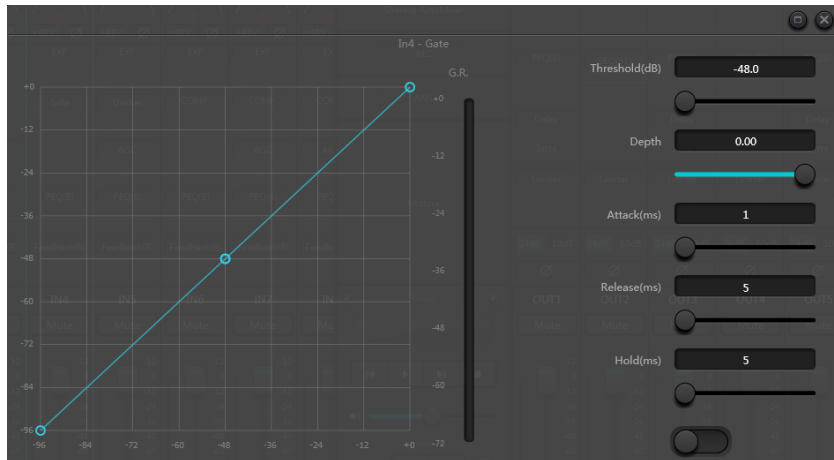

3.4.9 Ducker

Ducker: when the level of one channel exceeds the specified threshold, the level of the other channel will be attenuated, which is the dodging effect.

Threshold: the reference signal begins to decay above the threshold and recovers below the threshold.

Depth: the amount reduced by the evasive signal.

Attack: when the reference signal is above the threshold, the time to begin to attenuate the evasive channel signal.

Release: after the reference signal is below the threshold, the evasive signal returns to the original signal size.

Hold time: hold time refers to how long the dodging on the dodging channel remains after the control signal is below the threshold.

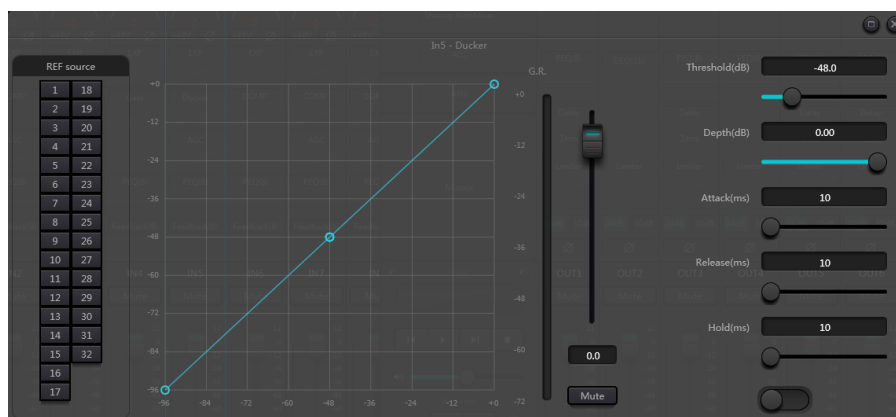

3.4.10 ANC

Noise Gain Compensator: automatically adjust output volume according to ambient noise induction and processing.

Maximum Gain: the maximum amount that can be adjusted.

Minimum Gain: the minimum amount that can be adjusted.

Gain-Sense Ratio: the ratio of lifting or attenuation.

Speed: the speed of lifting or attenuation.

Trim: gain.

Noise Threshold: greater than the starting gain, less than the reduction.

Distance: distance between reference and local signals.

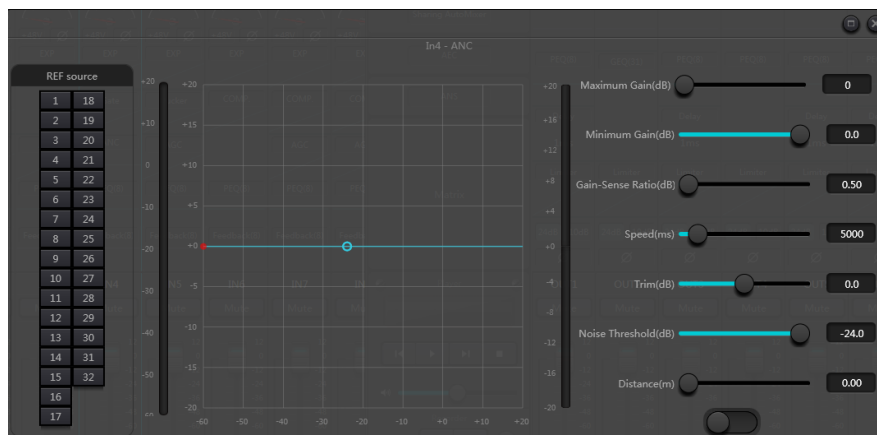

3.4.11 AutoMixer

The Dash Gain Sharing AutoMixer is a multichannel mixer that automatically lowers the level of non-active audio sources such as microphones while simultaneously riding the level of active sources to maintain the desired target gain. This eliminates the need for tedious and often impractical live mixing of audio sources. The alternative is to just leave all source channels open, however that can severely degrade the overall quality and user experience allowing hum, background noise, etc. from inactive open microphones to be mixed with the desired signals. The Dash Gain Sharing AutoMixer solves that problem elegantly by using the intelligence of the DSP to optimize the audio mix, prioritizing desired content while diminishing undesired content.

Gain Sharing provides the most natural sounding mix of multiple microphones. Some AutoMixers use gating technology to gate inactive microphones while maintaining a defined maximum Number of Open Mics (NOM). While this technique functionally 'works', one can imagine the unnatural sounding result as microphones are being effectively muted and unmuted during conversation. A Gain Sharing Automixer uses mathematics to reduce the individual gain of a microphone as microphones are added. Fundamentally, for every doubling of the NOM, the AutoMixer reduces the overall gain by 3dB. The effect is a seamless, natural, and conversational sounding mix.

There are two groups of control parameters in the Gain Sharing AutoMix module: main control parameters and channel control parameters.

Main Control Parameters

Gain: Sets the desired target gain for the output of the AutoMix.

Slope: Determines how aggressive the gain sharing is. Low Slope settings cause the module to behave just like a conventional mixer. High slope settings cause the inputs to attenuate more deeply for inactive microphones, similar to a gate. A value of around 2.0 provides the most natural sounding effect in most applications.

Response: Sets the speed at which the AutoMix operates. A faster response time may be needed if different speakers are speaking in quick succession however a response value that is too fast could cause unwanted 'pumping' of the audio between spoken words. Conversely, too slow of a response could cut off the beginning sounds of words. However, the very nature of the Gain Sharing algorithm provides for a faster on time than off, to help prevent this effect, even at very fast Response settings.

Practice shows that the most natural effect will be produced with a Response value between 100ms and 1000ms.

Mute: Mutes the output of the AutoMixer.

ON/OFF: The Auto Mixer has a master on/off switch which is used to enable or disable the module. The 'Gain Sharing AutoMix' indicator will be green when the module is ON.



Channel Control Parameters



Fader/Gain: Sets the channel gain. Faders can be used to tell the Gain Sharing algorithm the desired relative level of each channel. NOTE: Channel gain is after the input to the AutoMix engine. Channel level may still influence the gain adjustment of other channels even if the fader is all the way down.

Priority: Sets the priority level of the selected channel. This value feeds into the AutoMix engine and can influence automatic gain adjustment decisions. Priority values range from 0 to 10. The higher the value the higher the priority of the channel.

AutoMixer: Enables AutoMix participation of the selected channel.

Mute: Mutes the channel. NOTE: Mute is after the input to the AutoMix engine. A muted channel may still influence the gain adjustment of other channels in the AutoMix.

AutoMixer Application Notes

Both channel gain and channel mute in the AutoMix module are after the AutoMix engine in the signal chain. Therefore, as long as the channel is participating in the AutoMix it will influence the algorithm – even if the channel is muted or the gain is all the way down.

If two or more channels have the same signal level, the channel with the highest priority will get more auto gain. It should be noted that great care should be given when assigning priority values. It is best to avoid wide differences

in between channel priorities for example 0 and 10. If the channel with a value of 10 can recognize even background noise as valid content and then channels with a priority of 0 could be masked all together and never added to the AutoMix. This effect gets worse with higher Slope values. If it is necessary to have such diverse priorities, it is recommended to add a gate or expander to the highest priority channels to eliminate unwanted noise.

3.4.12 AEC

Acoustic Echo Canceller is a kind of digital audio signal processing technology. It is used in audio/video conference when conferees in local conference room are talking with one or more speakers certain distance away. AEC program increases remote speaker’s phonetic intelligibility via cancelling acoustic echo generated in local room.

Echo cancellation module for remote calls can be used to carry out local amplification of remote voice signals and attenuate the interference caused by acoustic echo. Its basic operation principle is simulating echo channel, estimating possible echo generated by remote signals and then minus the estimated signal from input signal of microphones, and thus there will be no echo generated in input voice signal to achieve the goal of cancelling echo.

There is only an echo cancellation module in DSP Controller. Two local input and remote output mixers are preset to realize multichannel signal participating echo cancellation as shown in the figure. A parameter can be adjusted:

Non-linear filter (NLP): Three types including Conservative, Moderate and Aggressive can be selected to determine echo suppression level.

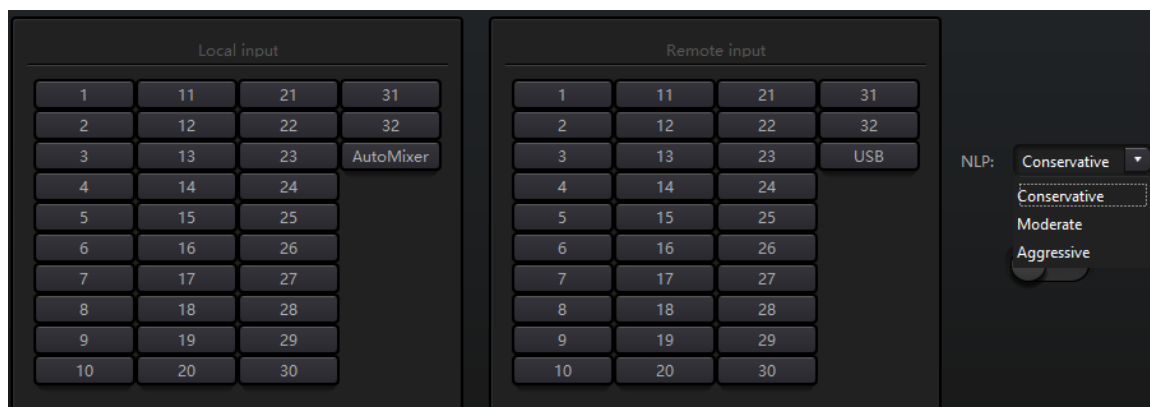

Note: The settings of echo cancellation module shall be used cooperatively with matrix module setting signal router.

Selection	Tail Time
Conservative	128ms
Moderate	256ms
Aggressive	512ms

3.4.13 ANS

Automatic Noise Suppression module can remove non-human voice effectively. It may distinguish human voice from non-human voice and treat the latter as noise. After its processing, only human voice is theoretically left for an audio file consisting of both human voice and noise.

There is only an echo cancellation module in DSP Controller. Multichannel mixers are preset to realize multichannel participating noise cancellation as shown in the figure.

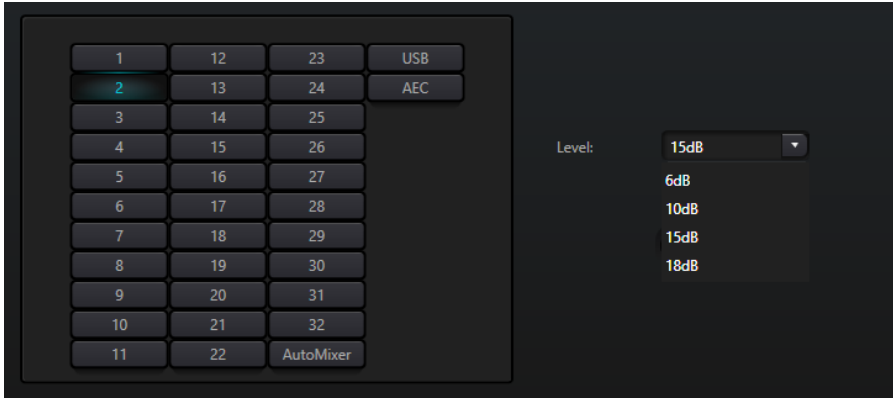

Suppression level: There are totally four levels for selection. dB here refers to the decibel of suppression noise reduction. The bigger the value, the more harm on voice generated, which is inevitable.

3.4.14 Matrix

Matrix has dual operation functions including router and sound mixing. As shown in the figure, the horizontal direction indicates the input channel, and the vertical direction indicates output channel. One-to-one input and output are the default setting. If it's necessary to mix voices of channel 1 and channel 2 and then output to channel 1, users only need to click 1s on both horizontal and vertical directions at output channel 1. If input 1 and 2 participate in auto mixing, then the output will not be influenced by it. Similarly, after setting auto mixing, echo cancellation and noise suppression module, users also need to set matrix to get correct signal route relation.

3.4.15 High & Low Pass Filter

Each output channel provides high- and low-pass modules which consist of high- and low-pass filters. Each filter has four kinds of parameters as follows:

Frequency: The cutoff frequency of filters. The cutoff frequency of Bessel and Butterworth is defined at -3 dB, and the cutoff frequency of Linkwitz-riley is defined at -6dB.

Gain: Gain setting influences the promotion and attenuation of full band.

Type: There are three types of filters including Bessel, Butterworth and Linkwitz-riley. Butterworth has the flattest passband.

Slope: It refers to attenuation values of transition zone of filters. There are totally 8 attenuation values including 6, 12, 18, 24, 30, 36, 42 and 48dB/Oct. For example, 24dB/Oct indicates that the attenuation range is 24dB for each octave difference existed in frequency in transition zone.

Users may click bottom activate button to activate high- or low-pass module.

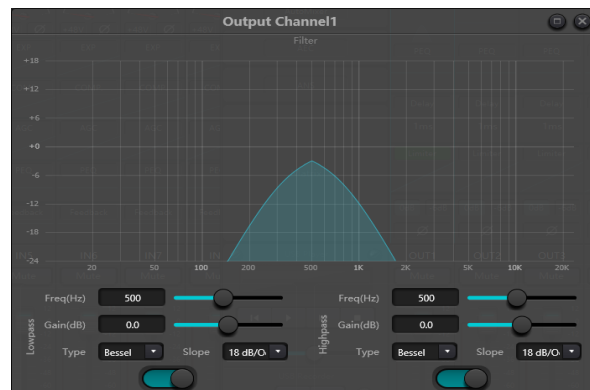

3.4.16 Delay



Activate button: Activate appointed delay module in modules and insert it into audio signal path to increase fixed delay time for signals.

Millisecond: Set delay time of delayer. The value ranges from 1 to 1, 200 milliseconds. Both meter and feet are alternate units for millisecond.

3.4.17 Output & Camera

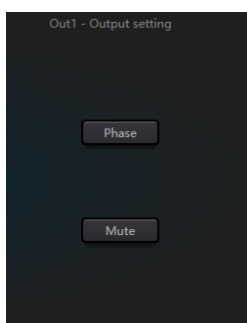

Invert: 180-degree audio signal phase invert.

Mute: Set mute/unmute.

Similarly, users can use right button to set part menu at output channels, which can be carried out based on requirements.

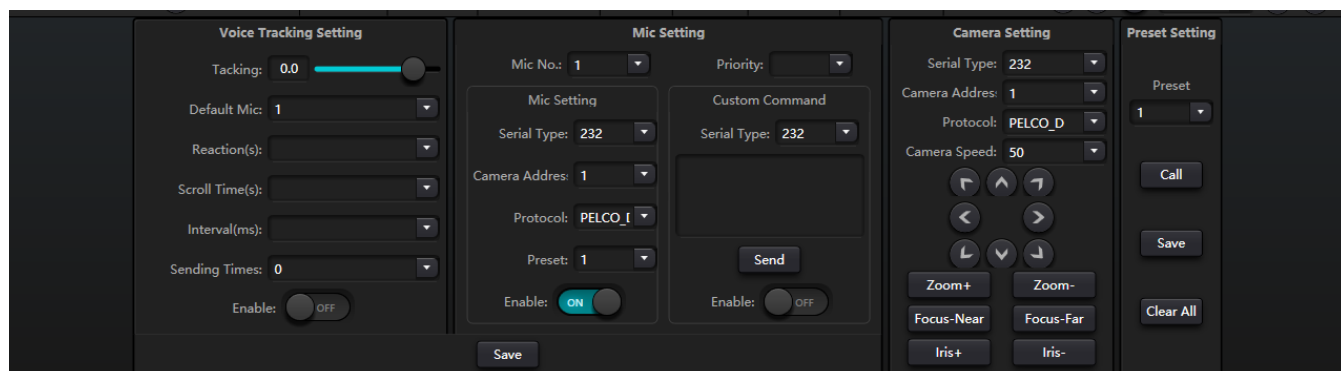

Voice tracking; set **tracking** threshold: detect microphone input signal greater than or equal to tracking threshold, the system automatically enables tracking parameters.

Default Mic: when all mics are not input, turn the camera to the default mic set position reaction time: the maximum intermittent time of the valid signal. If the microphone is used to speak, the **reaction** time is set to 3 seconds, and the signal is still considered to be valid for 3 seconds in the middle of the speech, and more than 3 seconds, is regarded as invalid. Cut back the default Mike time: the shortest speaking time required for the camera to switch to a valid position. If the microphone is used to speak, the speaking time must be longer than the "switching time ", the channel signal is considered to be valid, and then the camera automatically turns to the set position. Usually "switching time" is greater than "reaction time ".

Wheel gap: the number of times each time a camera switch command is sent: the number of times a camera switch command is sent, such as 0 for special processing, only once triggered.

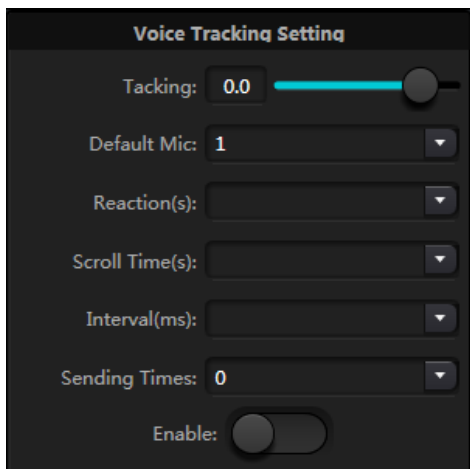

Mic sets the microphone number: generally corresponding to the input channel of the device, that is, the channel number connected by the mic. Priority: the smaller the priority series, the higher the priority level, when the priority is the same, according to the trigger priority order; if two mics speak at the same time, The camera automatically rotates to the preset bit corresponding to a mic with a small priority (that is, high priority) or sends a command corresponding to a mic with a small priority (that is, high priority); but if the two mics have the same priority, the first checked signal shall prevail. preset point, serial port number, camera address, protocol, and camera related, must correspond to the actual connection of the camera. Enable: when the device detects an input signal (usually when someone speaks), it automatically sends the corresponding command to the defined serial port, and then it can set the command in advance. But without checking enable Custom Command, the device does not send automatically, but can still click the send button to send input box command to the specified serial port. Click Save to save the parameter to the device when the channel's mic is associated with the corresponding camera address. Then the "enable microphone setting" option is used to determine whether the microphone setting is a camera debugging interface when tracking is enabled. Finally, the parameters of this part will be saved on the camera.

3.4.18 USB Soundcard

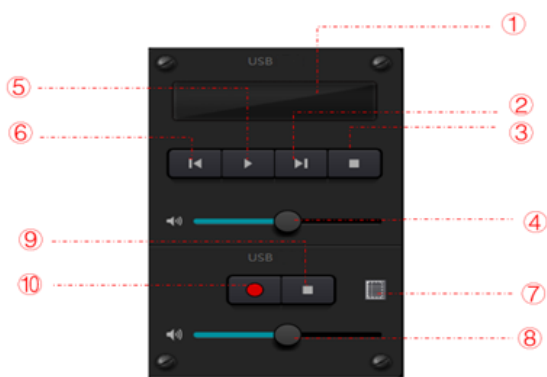

USB soundcard is used to carry out two functions, realizing recording and broadcasting and teleconferences using personal computers. After going through echo and noise cancellation modules, USB voice may access to teleconferences easily. USB broadcasting function on the software interface can only be used for recording and broadcasting function.



- ① Song playing information, double click to enter playlist
- ② Next song
- ③ Pause
- ④ Song volume adjustment
- ⑤ Play
- ⑥ Prev. song
- ⑦ Sound recording list
- ⑧ Sound recording volume adjustment
- ⑨ Stop recording
- ⑩ Start recording

Soundcard Setting

USB cable with double ends of Type-C can be used to connect DSP processor and computer host. For initial connection, "Found New Hardware" will pop up on computer screen, and the driver will be installed automatically. After installation, USB soundcard will appear in computer soundcard list as shown in the figure. Users may select USB soundcard in soundcard setting at software playlist.

Users may operate song files in playlist as well as save them as playlist. They may also directly open them when using the device next time. As shown in the figure, click  at the bottom of the playlist to open file folder and select songs to be played,  to clear the playlist and  to enter the interface of soundcard setting.

3.5 Setting Menu

3.5.1 File Menu

In offline mode, click the pop up file dialog and open an existed default document with suffix *.uma, or right click on the default document to open.

"Save as" refers to saving presets on the application to local hard disk to realize easy copy and store.

3.5.2 Device Setting

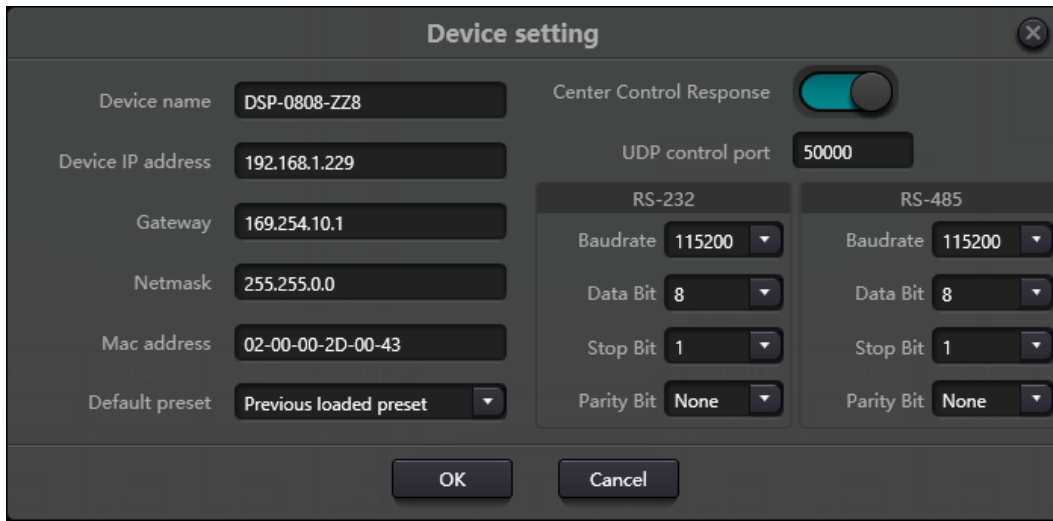

Information like device name, network address and baud rate can be set on device setting. The maximum length of the device name is 16 characters or 5 Chinese characters.

Default startup: Two startup preset modes are available for selection. One is any preset from 16 presets acting as startup preset. Each boot will start with it. Another is selecting previous upload preset and taking the last preset before power outage as the preset of next startup.

3.5.3 GPIO Setting

Open the software interface of GPIO settings. The device has total 8 GPIOs that allow independent input or output configuration.

Input GPIOs have preset, router, gain, mute, command, analog-to digital gain for selection.

Output GPIOs have preset, level, mute, and command for selection.

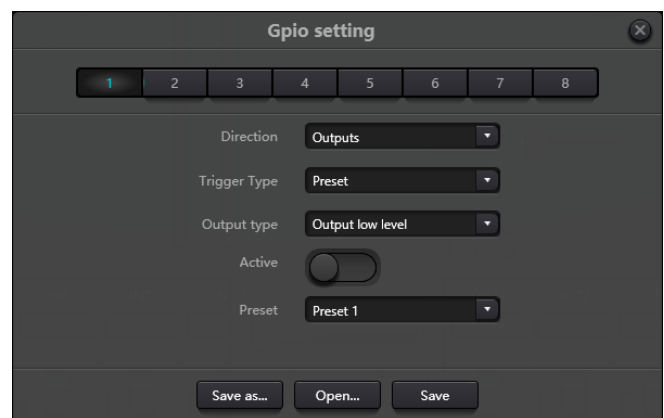
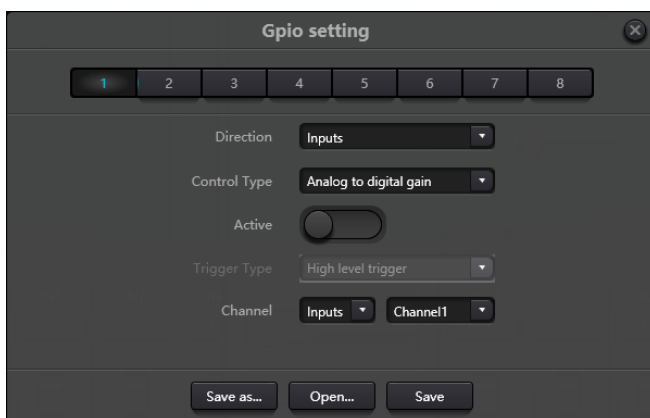

Input GPIO Setting

Preset

Trigger types: high level trigger/low level trigger/high level trigger, low level cancellation/low level trigger, high level cancellation, i.e., rising edge/falling edge trigger/rising edge trigger, falling edge cancellation/falling edge trigger, rising edge cancellation.

Preset: It will change to preset when jump type of hardware GPIO port and trigger type of software setting are consistent.

Routing

Trigger types: same as above

Input & output: select input channel mixing corresponding to output channel.

Carry out mixing/cancel mixing action when the trigger condition is satisfied.

Gain

Trigger types: same as above

Channels: select input or output channel

Step length: increase step length in dB based on original gain got by the channel.

Mute/Cancel Mute

Trigger types: same as above

Channels: select input or output channel

Command

Trigger types: same as above

Command: **The command code will be sent through RS232** when the trigger condition is satisfied. Maximum 32 bytes.

Remember that the RS-232 port has Tx and Rx, any command sent can be received by the device by interconnecting these terminals.

Analog-to-digital Gain

Direction: Inputs
Control Type: Analog to digital gain
Active:
Trigger Type: High level trigger
Channel: Inputs Channel1

Analog-to-digital gain is very useful when connecting potentiometer externally. It may adjust input or output channel gain. It looks like rotary encoder. The difference between them is potentiometer analogs and adjusts voltage and current while encoder is digital and transmit the binary codes of 0 and 1.

Output GPIO Setting

Preset

Direction: Outputs
Trigger Type: Preset
Output type: Output low level
Active:
Preset: Preset 1

Output types: high level/low level

Preset: Corresponding GPIO port outputs high level or low level when changing to it.

Level

Direction: Outputs
Trigger Type: Level
Output type: Output low level
Active:
Channel: Inputs Channel1
Level: 0.0

Output types: high level/low level

Channels: appointed input or output channel

Level: GPIO outputs high/low level when appointed channel level reaches preset level threshold.

Mute

Direction: Outputs
Trigger Type: Mute
Output type: Output low level
Active:
Channel: Inputs Channel1

Output types: high level/low level

Channel: Appointed input/output channel. Preset high/low level is output when the channel is muted. On the contrary, the opposite level will be output when cancelling mute.

3.5.4 Group Setting

The interface of group setting contains two labels including input and output labels. Maximum 16 groups can be set at each label. A channel can only participate in one group. In the same group, their channel volume adjustment and mute are synchronous. Other module parameters are out of synchronization, which is the biggest difference between them and the function of Link.



There are totally 16 groups. 1-device maximum number of channels can be selected for each group. the maximum number of channels is determined by the device type you purchased. Channels are set into one group which will be differentiated by a color in main interface.

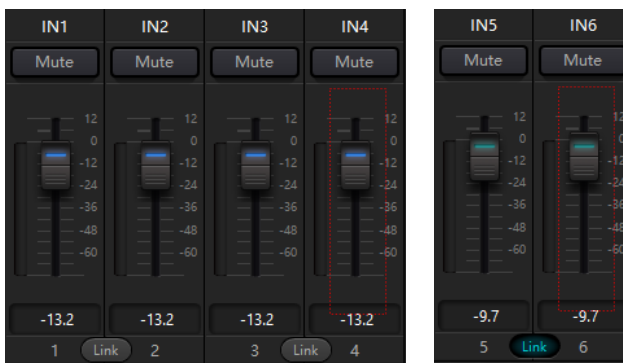

The relationship between groups and link: The channel participating in group won't participate in LINK, which means group's priority is higher than LINK. The difference between groups and LINK is that groups can only control channel gain and mute while LINK links all parameters at the channel.

3.5.5 Panel Setting

Panel setting include one panel type which are button and OLED panels. Use cables to connect multiple physical panels with DSP device via panel setting, and then achieve the aim of panel controlling DSP device by setting panel easily.

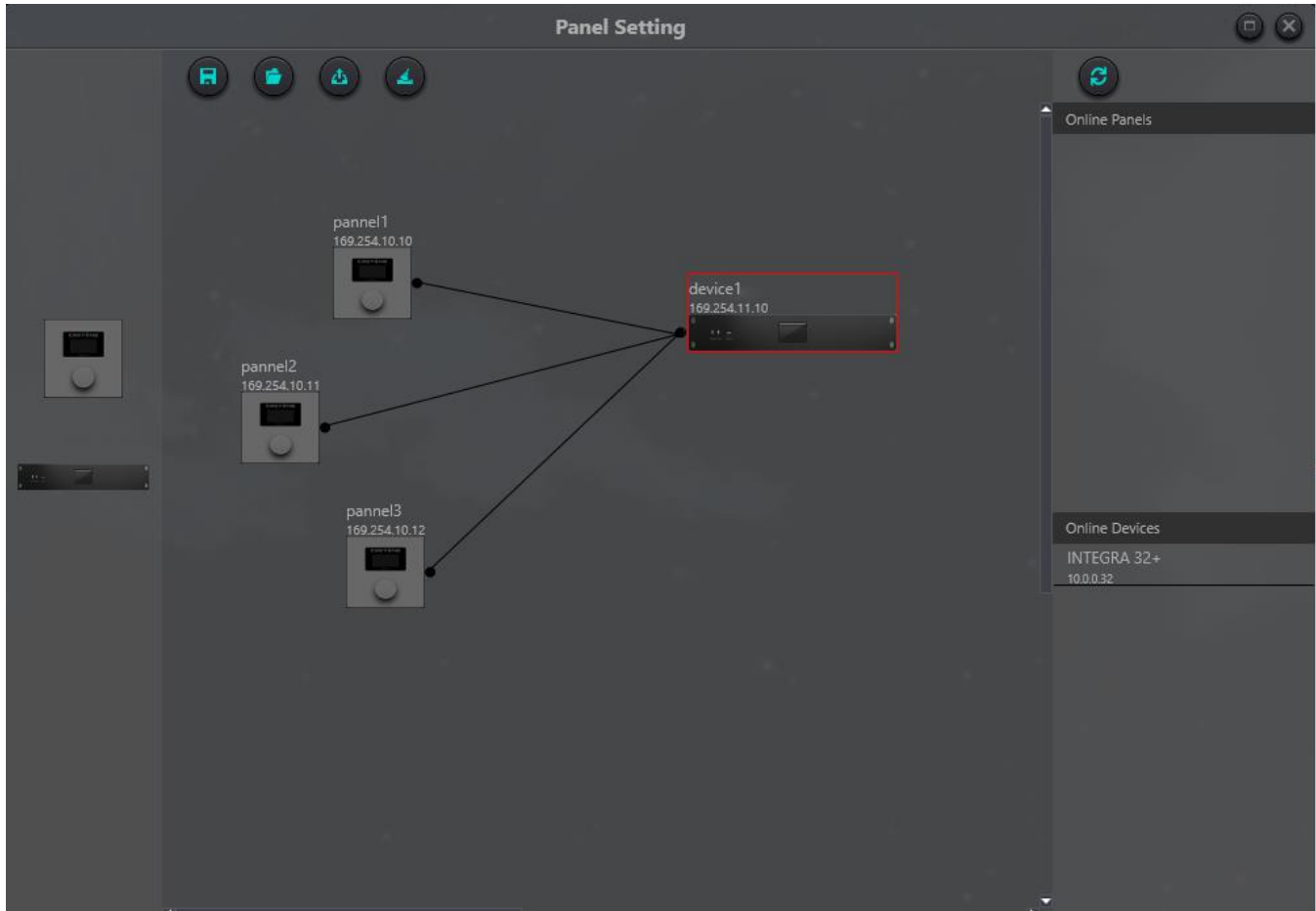

Offline device: It suits for offline edit status. Firstly, commissioning engineer configures panel parameters locally, and then download it to online panel. It is no doubt that the panel can be edited directly online. Drag offline device from the column of online panel to panel design area and then double click to edit it.

Please note that there is a small circle on both panel and device. Click the circle and then draw a line, select target device, and then the connection between two devices are established by this way.

Double click the panel in design area to enter panel configuration interface. The configuration of two panels is going to be described below. After finishing configuration, click the toolbar download icon  to download the panel configuration to hardware.

It is not recommended to use more than 16 units in one installation on the same device.

Wall Control Panel

Consists of a 1.3" OLED screen and a knob. OLED screen display strategy is classified according to menu. There are totally three types of menus including menu, buttons and presets. Double click a OLED screen in design area of the screen to enter its detailed setting as shown below.

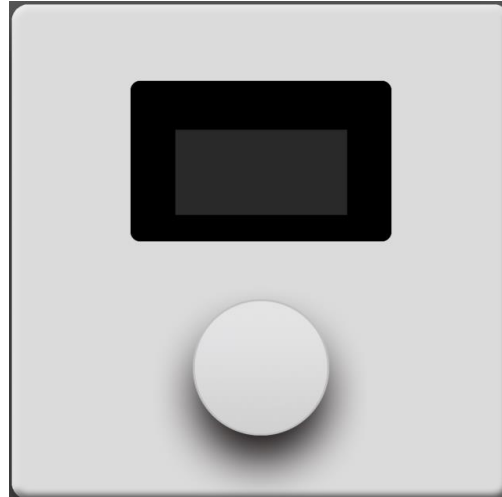
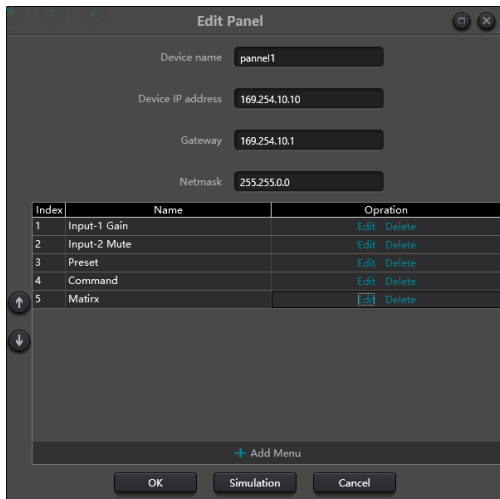

Click "add menu" to pop up menu selection box, choose corresponding menu and confirm it. After finishing the setting of software menu configuration, click toolbar download icon to download the configuration to panel hardware.

Operation steps of panel:

1. Display panel name and IP address on main interface and turn the knob left or right to switch menu.
2. Press the button on the knob, and the second row on menu interface starts to flash, which indicates that it enters edit mode.
3. Turn the knob left or right to change value.
4. Press the button on the knob again to edit mode and go back to menu mode.



This is the menu editing screen where we can see the types of menus we can use.

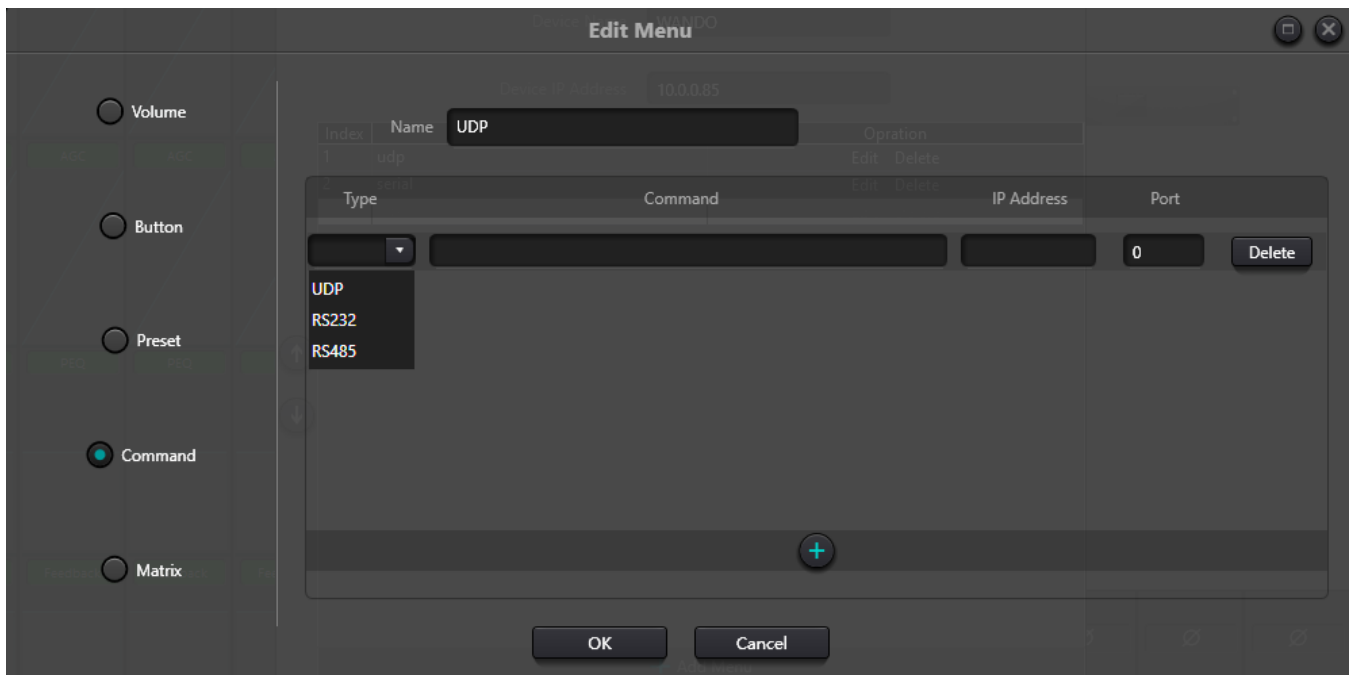

Let's pay special attention to this type of menu that allows us to send commands with different protocols, we can add one after the other, the message must be written in HEX, remember that thanks to the command capture tool we can order any action that is not predefined in the other menus.

Remember that UDP commands will be sent by the device, even to other third-party devices on the same network; serial commands are sent over the physical ports of device.

The device does not accept shielded RJ45 connectors.

3.5.7 Help Menu

(1) Central command

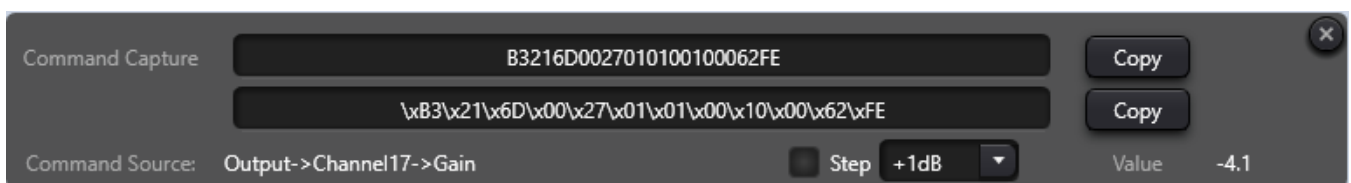

Open central control command window and click parameters to be controlled on interface, then the window will display current command immediately. Copy the command and then use it to manage devices.

The first line shows the message in HEX, the second line is an example of how it would be programmed to be launched in languages such as JavaScript or Python, if you want to send the message as ASCII do not hesitate to visit the annex of such commands or format the message with the conventional form "\$XX".

(2) Device upgrade

Device upgrade can be carried out through UDP. Connect the device, click setting-help-device upgrade. A file choice box will be popped up at this point, and then choose processor upgrade file (*.bin).

(3) About

Display version number, tech support contact information and copyright info., etc.

4. Control

4.1 External Control Programmer

External control programmer supports UDP and RS232 and controls protocols covering all controls parameters of processor, including parameter controls, parameter acquisition and preset calling.

When UDP controls are used, the default port is 50000. Ports can be set in "Device Setting" via upper computer software.

When using RS232 controls are used, the default baud rate is 115200, digit bits is 8, and stop bit is 1, no parity bit. Similarly, they can be set in "Device Setting". **The interval between messages shall keep more than 100mS for RS232 sending.**

If central control needs reply, please turn on central control reply switch in "Device Setting".

The screenshot shows a 'Device setting' window with the following configuration:

- Device name: DSP-0808-ZZ8
- Device IP address: 192.168.1.229
- Gateway: 169.254.10.1
- Netmask: 255.255.0.0
- Mac address: 02-00-00-2D-00-43
- Default preset: Previous loaded preset
- Center Control Response:
- UDP control port: 50000
- RS-232 settings: Baudrate 115200, Data Bit 8, Stop Bit 1, Parity Bit None
- RS-485 settings: Baudrate 115200, Data Bit 8, Stop Bit 1, Parity Bit None

4.2 Control Protocol

Because of historical reasons, the latest control protocol adopts variable-length and is fully compatible with old fixed-length control protocols. In protocols, the fourth byte is used to distinguish versions. 0- indicates V1 version (previous versions) and 1- indicates V2 version (current protocol version).

The difference between V1 and V2 is V1 may control all processing module parameters, but one command can only control one parameter. If a parameter is needed to control continuous multiple channels, then V2 version shall be used. In other words, in condition that users need to press one key on key panel to trigger GPIO output high-/low-level of devices, or send a command via RS232/RS485, then V2 version will be the best choice.

Software coding rules (total 12 bytes)

byte1	byte2	byte3	byte4	byte5~132
0xb3	Message Type	Length	Version No.	Data

V1:

Information types (byte2): There are three information types including 0x21 (parameter controls), 0x22 (parameter acquisition) and 0x13 (scenario switch).

Length (byte3): invalid.

0x21 (parameter control):

At this point, Databyte5~12 respectively

byte 5~6	byte 7~8	byte 9~10	byte 11~12
Module ID	Parameter Type	Parameter 1	Parameter 2

Please refer to Appendix A to get the distribution of **Module ID** (byte5~6).

Please refer to Appendix B for **Parameter types** (byte7~8).

When **Parameter 1** (byte9~10) has only one parameter, then only parameter 1 is valid, such as control compressor switch.

Parameter 2 (byte11~12) only valid when there are two parameters, such as control output channel 1 mute. Parameter value 1 shall be filled in input channel number from 0. Parameter value 2 shall be filled in 1 (mute).

Exception: Matrix routing has three parameters. The first one is input channel number, the second one is output channel number, and the third one is routing switch. At this point, byte9 of parameter value 1 shall be filled in input channel numbers, byte 10 shall be filled in output channel number, and parameter 2 shall be filled in routing switch.

0x22 (Parameter Acquisition):

Parameter acquisition rules are the same with parameter controls. The difference between them is values acquired shall be filled in parameter 1 and parameter 2.

0x13 (Scenario Switch):

Users only need to fill scenario numbers (0~15) in byte5 and 0 in byte6~12.

Note: Central control command of V1 version can acquire code through software menu bar of PC. For customized development, please use this protocol rule.

V2:

Message types (byte2): There are three message types (byte2) including 0x21 (parameter controls) , 0x22 (parameter acquisition) , 0x13 (scenario switch) , 0x74 (other controls) and 0x6e (Dante routing) .

Length (byte3): Fill in corresponding data section length based on information type. The length can be longer when actual sending is carried out. Total data volume can be got through adding 4 byte header information to data length.

1. Parameter Control (0x21)

At this point, the formats of data section are as follows.

byte5	byte6	byte7	byte8	byte9~72
Input/Output	Start Channel	End Channel	Parameter Type	Parameter Value

byte5: It indicate control input or output channel, 0x2- input channels and 0x1-output channels.

byte6-7: They indicate start and end channel numbers. Channel numbers start from 0.

byte8: This kind of parameter is the same with V1 version. Please refer to Appendix B.

byte9-40: Fill in parameter values of start to end channels. It shall be filled in from the ninth byte. Each parameter value shall take two bytes.

2. Parameter Acquisition (0x22)

Data section format is the same with parameter controls. Parameter values may not be filled in. acquired parameters will be filled in this position.

3. Scenario Switch (0x13)

byte5: Fill in scenario numbers (0-15).

byte6-8: Fill in 0.

4. Other Controls (0x74)

Other controls include but not limited to GPIO, RS232, RS485 and central control replies. The protocol formats are as follows.

GPIO:

byte5	byte6	byte7	byte8	byte9	byte10	byte11	byte12
Control Type	Data Length	Reserved	Reserved	GPIO Direction	Start GPIO	End GPIO	Value

The controlling type for byte5 is 1.

The data length of byte6 is fixed as four bytes.

Byte9 GPIO direction, set input or output. Value 0 indicates input, and value 1 indicates output.

Byte10-11 start GPIO and end GPIO. DSP devices totally have eight GPIOs, which are indicated with number 0-7.

Byte12 is determined according to byte9GPIO direction. The field shall be filled in high (1) /low (0) level for output settings. The field is a return field to read GPIO level value on devices for input settings.

Example:

Set GPIO 1-8 output high: b374080101000000010007ff

Read GPIO 1-8 level value: b37408010100000000000700

The return value is: b374080101000000000007FF

RS232/RS485:

byte5	byte6	byte7	byte8	byte9-132
Control Type	Data Length	Reserved	Reserved	Data

Byte5 is 2 when controlling type RS232, and 3 for RS485.

The data length of byte6 refers to data length that shall be sent via RS232/485 currently.

Byte9-132 shall be filled in data sent by RS232/485.

Example:

Output the string "Hello, DSP." from RS232: b3741001020c000048656c6c6fa3ac4453502e00

Output the string "Hello, DSP." from RS485: b3741001030c000048656c6c6fa3ac4453502e00

Note: Set RS485 to send mode first.

Central control replies:

byte5	byte6	byte7	byte8	byte9
Control Type	Data Length	Reserved	Reserved	Reply Switch

Byte5 controlling type is 4.

The data length of byte6 is 1.

When byte9 is 1, it means turning on central control replies switch; and 0 means turning off replies.

Example:

Enable the central control reply: b37408010400000001000000

Close the central control reply: b37408010400000000000000

5. Dante Routing (0x6e)

Data section formats are:

byte5	byte6	byte7	byte8	byte9-24	byte25-40
Dante Channel No.	Routing Switch	Reserved	Reserved	Subscribed channel name	Subscribed device name

Byte5 Dante channel numbers. The difference is Dante channel numbers start from 1.

Byte6 Dante channel, subscribe/cancel subscription of appointed channels of Dante devices indicated with byte25-49. The appointed channels are indicated with byte9-24 channel names.

Example:

The directive code is as follows: b37414010500

The reply is as follows: b3741401050000004453502d3838442d313337306165000008080808

4.3 Serial Port-to-UDP (RS232 To UDP)

DSP devices support RS232 translating into UDP. The protocol formats are as follows.

4bytes prefix	4bytes	2bytes	1byte	1byte	128bytes
UDP:	IP Address	Port	Data Length	Reserved	Data

After receiving the protocol format data packet, RS232 send data in the protocol to appoint IP addresses and devices at ports.

Example:

When sending data "HELLO DSP to device port 50000 of device "192.168.10.22", the protocol commands are as follows.

4 bytes prefix	4 bytes	2 bytes	1 byte	1 byte	128 bytes
0x3a504455 (':PDU')	0x1610A8C0	0xC350	0x09	0x00	"HELLO DSP"

Application scenario: The function can be applied in scenarios when many central control hosts have no network port. As shown in the figure, central control hosts translate network commands through serial ports to control any network device.

Important tip, if you are not familiar with the formation of these types of messages for external control, use the "Command Capture" tool of your software to assist in the formation of such a command.

5. FAQs

1. How to restore factory setting?

Connect it to computer through RS232 and run serial port software (SecureCRT is recommended to use). The default baud rate of series ports is 115200, 8 data bits, no parity check, one stop bit. After connecting SecureCRT to serial ports, long press to enter at terminal interface to reboot the computer and enter bootloader boot dialog box as shown in the figure.

Command explanation:

del config: delete configuration information, such as network configurations like IP address. The device restores to default IP 169.254.20.227 after deleting.

del scenes: delete preset. All 16 presets of DSP devices restore to default values.

del all: delete all sections except the program.

Note: There may be no echo after the installation of some SecureCRTs. Please check "Local echo" by going to Options->Session Options, as shown in the figure.

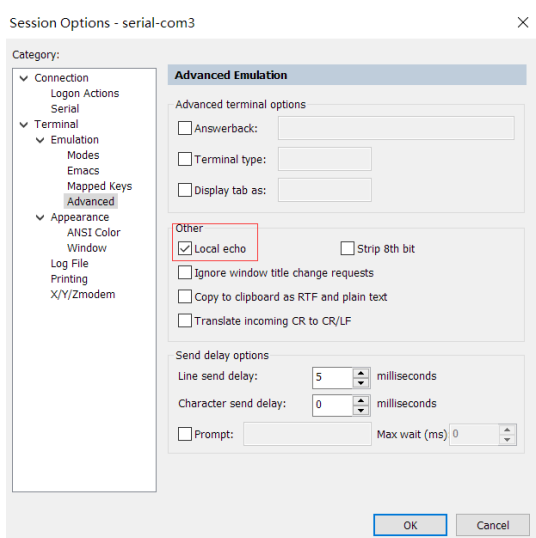

Appendix A: Module ID Distribution

Module Name	ID	Module Name	ID
Input source	299	Output Channel 1-32 High & Low Pass	167~198
Input Channel 1-32 Expander	1~32	Output Channel 1-32 Equalizer	199~230
Input Channel 1-32 Compressor	33~64	Output Channel 1-32 Delayer	231~262
Input Channel 1-32 Auto Gain	65~95	Output Channel 1-32 Limiter	263~294
Input Channel 1-32 Equalizer	97~128		
Input Channel 1-32 Feedback Inhibition	129~160		
AutoMixer	161	Echo Canceller	162
Echo Cancellation	163	Noise Suppressor	164
Noise Suppression	165		
Mixer	166		
Output	295		
System Control	296		

Appendix B: Module Parameter Types (1)

Module Name	Parameter Type	Description	Module Name	Parameter Type	Description
Input Source	0x1	Gain	Output	0x10	Gain Compensation
	0x2	Mute		0x11	Link
	0x3	Sensitivity		0x12	Channel Level

	0x4	Phantom Power Switch		0x1	Gain
	0x5	Signal Generator Type		0x2	Mute
	0x6	Signal Generator Frequency		0x3	Channel Name
	0x7	Sine Wave Gain Size		0x4	Invert
	0x8	Channel Name		0x5	Sensitivity
	0x9	Invert		0x6	Gain Compensation
	0x10	Gain Compensation		0x7	Link
	0x11	Link		0x8	Channel Level
	0x12	Channel Level	Expander	0x1	Switch
Delayer	0x1	Bypass Switch		0x2	Threshold
	0x2	Millisecond		0x3	Ratio
	0x3	Microsecond		0x4	Setup Time
Equalizer	0x1	Total Equalizer Switch		0x5	Release Time
	0x2	Child Segment Switch	Compressor	0x1	Compressor Switch
	0x3	Frequency		0x2	Compressor Threshold
	0x4	Gain		0x3	Compressor Ratio
	0x5	Q Value		0x4	Setup Time
	0x6	Type		0x5	Recovery Time
				0x6	Gain Compensation

Appendix B: Module Parameter Types (2)

Module Name	Parameter Type	Description	Module Name	Parameter Type	Description
Mixer	0x1	Mixer Switch	Feedback Inhibition	0x1	Switch
	0x2	Mixer Gain		0x2	Feedback Point Frequency
High & Low Pass	0x1	High Pass Switch		0x3	Feedback Point Gain
	0x2	High Pass Type		0x6	Preset
	0x3	High Pass Slope		0x7	Clear
	0x4	High Pass Frequency		0x8	Panic Threshold
	0x5	High Pass Gain		0x9	Feedback
	0x11	Low Pass Switch	Auto Gain	0x1	Switch
	0x12	Low Pass Type		0x2	Threshold
	0x13	Low Pass Slope		0x3	Target Threshold
	0x14	Low Pass Frequency		0x4	Ratio
	0x15	Low Pass Gain		0x5	Setup Time
Auto Mix	0x1	Total Mute		0x6	Release Time
	0x2	Total Gain	Echo Cancellation	0x1	Echo Cancellation Switch
	0x3	Slope		0x2	Echo Cancellation Mode
	0x4	Response Time	Noise Suppression	0x1	Noise Suppression Switch
	0x5	Channel Auto Switch		0x2	Noise Suppression Mode
	0x6	Channel Mute	System Control	0x1	System Mute
	0x7	Channel Gain		0x2	System Gain
	0x8	Priority			

Appendix C: ASCII control command.

Previously:

a) Because the starting bit of the channel is 0, it can be understood that the 0-3 channel corresponds to the IN1-4 software display channel, and 0-3 is only for example. The actual number of channels shall prevail the device model.

b) In the function on/off settings, 1 is open and 0 is off; For example, set:output#mute#0-3#1. The last 1 stands for "turn on mute".

Commands:

Input volume control and acquisition

```
set:input#gain#0-3#1
```

(Setting: Enter #Gain #Channel Number # to 1dB)

```
get:input#gain#0-3 --> get:input#gain#0-3#1#1#1#1
```

(Get: Input #Gain#Channel Number)

Return Information Example:

```
get:input#gain#0-3#1#1#1#1#1
```

(Input 1-4 channel volume is 1/1/1/1 in turn)

Output volume control and acquisition

```
set:output#gain#0-3#1
```

```
get:output#gain#0-3 --> get:output#gain#0-3#1#1#1#1
```

Phantom power supply control and acquisition

```
set:input#phant#0-3#1
```

get:input#phant#0-3 --> get:input#phant#0-3#1#1#1#1

Input Mute Control and Acquisition

set:input#mute#0-3#1

get:input#mute#0-3 --> get:input#mute#0-3#1#1#1#1

Output mute control and acquisition

set:output#mute#0-3#1

get:output#mute#0-3 -> get:output#mute#0-3#1#1#1#1

Control and acquisition of sensitivity

set:input#sens#0-3#1

get:input#sens#0-3 -> get:input#sens#0-3#1#1#1#1

Control acquisition of matrices: multiple inputs control a single output, and one input controls multiple outputs.

set:mixer#switch#0#0-3#1

(set input 1 to output 1 and 4 routes to open)

set:mixer#switch#0-3#0#1

(set input 1 to 4 to output 1 route open)

set:mixer#gain#0-3#0#1

(set input 1 to 4 to output 1 route gain 1db)

get:mixer#switch#0-3#0

(0-3:input,0:output)

get:mixer#switch#0-3#0#1#0#1#1

Invocation and Saving of Scenarios scene.

toggle #3

(scene call, pc is displayed as scene 4)

scene:save#3

(save scene)

Input level acquisition.

get:input#level#0-3 -> get:input#level#0-3 #-105.4#-102.5#-105.2#-104.8

Output level acquisition

get:output#level#0-3 -> get:output#level#0-3#-56.0#-40.8#-43.6#-46.4

System Mute Control and Acquisition. set:sysctl#mute#1

(on system mute)

get:sysctl#mute -> get:sysctl#mute#1

Settings and getting the channel name of the input and output .

set:input#name#0#1

get:input#name#0-3 -> get:input#name#0-3#IN1#IN2#IN3#IN4

Input and output inverting control and acquisition.

set:input#phase#0-3#1

set:output#phase#0-3#1

get:input#phase#0-3 -> get:input#phase#0-3#1#1#1#1

get:output#phase#0-3 -> get:output#phase#0-3#1#1#1#1

Input and output step control and acquisition.

set:input#step#0-3#10 set:output#step#0-3#10

Input and output link control and acquisition.

set:input#link#0-3#1 set:output#link#0-3#1 get:input#link#0-3 ->

get:input#link#0-3#1#1#1#1 get:output#link#0-3 ->

get:output#link#0-3#1#1#1#1

Control and acquisition of signal generators.

set:input#type#0-3#1

get:input#type#0-3 -> get:input#type#0-3#1#1#1#1

Restore factory settings control.

set:refactory

Scene Reset Control.

set:rescene

Get the name of the scene that is set arbitrarily.

set:scene#name#0-3#pre1

(PC only supports UTF-8 encoding)

get:scene#name#0-3

(scene number: 0-15)

get:scene#name#0-3#pre1#pre1#pre1#pre1#pre1

Module name:input,output|mixer item.

(input)mute,gain,sens,phant,type,freq,name,phase,step,link,level

(output)mute,gain,name,step,link,level

(mixer)switch,gain

(scene)toggle,save,name

(sysctl)mute

(rescene)

(refactory)

Set the instruction format.

set: Module name #itemname #Start Channel-End Channel # Parameter value

set:input#mute#0-3#0/1

Get the instruction format.

get: Module name #itemname #Start Channel- End Channel

get:input#mute#0-3